

YUKEN



ALA Industries Limited
1150 Southpoint Drive, Ste. D
Valparaiso, IN 46385-6236
Tel: 219-465-4197
Toll Free: 877-419-8536
Fax: 219-477-4194



www.yuken-usa.com

JT-02-*-10 Semiconductor Type Pressure Switches

These pressure switches have built-in electronic circuits on a semiconductor pressure sensor. An open collector insulated by a photocoupler has been used for the output. Since the use of semiconductors has put movable parts away from the sensor section, high reliability and durability can be obtained.

These pressure switches are suitable for applications that require not only compact, light weight and vibration-proof features, but are also a better substitute to conventional pressure switches.

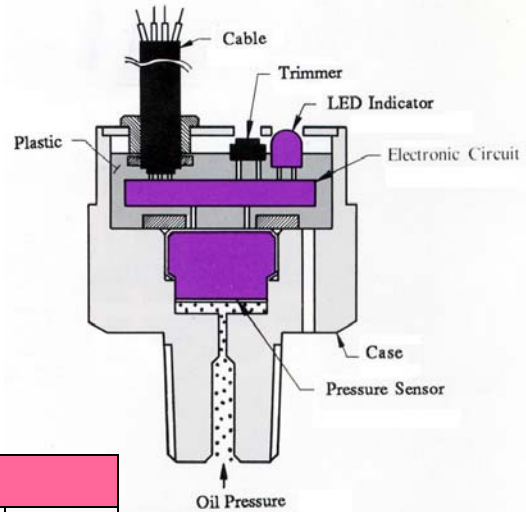

JIS
Graphic Symbol

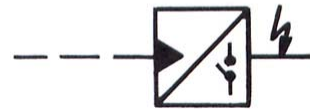

Model Number Designation				
J	T	-02	-100	-10
Series Number	Type of Mounting	Valve Size	Max. Pressure Setting (PSI) MPa	Design Number
J: Semiconductor Type Pressure Switch	T: Threaded Connection	02	35: 508 (3.5) 100: 1450 (10) 350: 5082 (35)	10

Design numbers are subject to change, but installation dimensions remain as shown for design numbers 10 through 19

Ratings				
Description	Model No.	JT-02-35-10	JT-02-100-10	Jt-02-350-10
Max. Operating Pressure	PSI (MPa)	1450 (10)	1450 (10)	5082 (35)
Proof Pressure	PSI (MPa)	2904 (20)	2904 (20)	7623 (52.5)
Pressure Setting Range	PSI (MPa)	14.5-508 (0.1-3.5)	145-1450 (1-10)	508-5082 (3.5-35)
Pressure Setting (ON Pressure Setting)	Single Adjustment ON Trimmer Setting (Variable Resistor)*			
Differential Pressure Setting (OFF Pressure Setting)	Single Adjustment DIFF Trimmer Setting (-1 to -10% of the ON Pressure Setting)*			
Sign on act.	When the ON Pressure, the LED Indicator Lights			
Output Source	Open Collector (Photocoupler Insulated) Maximum Operating Voltage: 35 VDC; Maximum Current: 100 mA.			
Power Source	10 to 28 VDC (ripple included); A constant-voltage power supply must be used. Current consumption: 10 mA.			
Insulation Resistance	100 MΩ or more			
Response Time	20 ms	20 ms (Damper Contained)		
Repeatability	Approximately 0.5%			
Operating Temperature Range Fahrenheit (Celsius)	-24° to +158° F (-20° to +70° C)			
Setting Fluctuation with Temperature Drift	50° F (10° C) 1% of less of the maximum operating pressure relative to 50° F (10° C) change			
Storage Temperature Range Fahrenheit (Celsius)	-80° to +158° F (-20° to +70° C)			
Dust/Water proofness	IP54 (JIS C 4520—JIS C 0920)			
Vibration Resistance	10G (JIS C 3025)			
Shock Resistance	10G			
Mass	6 oz (175 g)			

* Trimmer Rotation Angle 0° to 230°

** IP54 Indicates the protection form and protection grade of the housing structure in conformity with the IEC529 (International Electrotechnical Commission)

JT-02-*-10 Semiconductor Type Pressure Switches

Hydraulic Fluids

• Types Of Hydraulic Fluid

- Petroleum base oil
- Phosphate ester type fluids
- Polyor ester type fluids
- Water glycol type fluids
- Water in oil emulsion type fluids

Care in Application

Voltage-proof test should not be carried out as semiconductor has been used

• Recommended Viscosity and Oil Temperatures

- Viscosity ranging between 15 and 400 cSt (mm^2/s)
- Oil Temperature between -80° to $+158^\circ$ F (-20° to $+70^\circ$ C)
- Use Hydraulic fluids which satisfy the recommended viscosity and oil temperature given above.

Mounting Dimensions

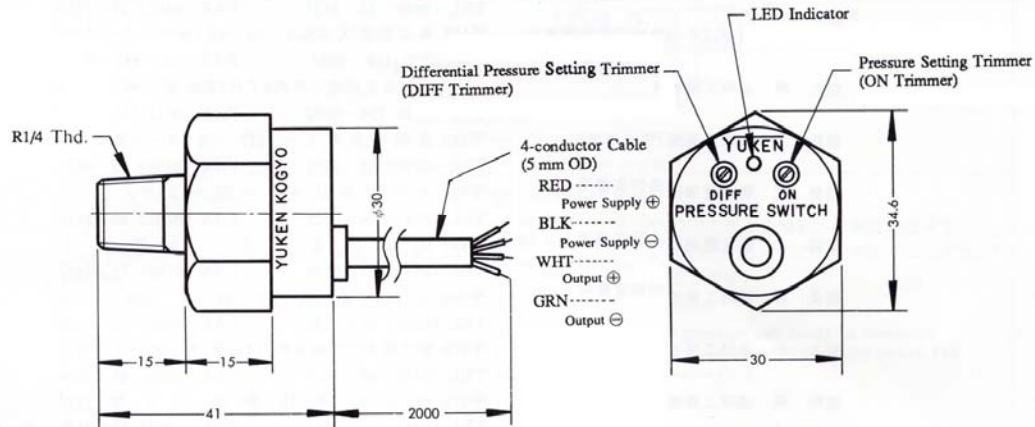

Adjustment

1. Before starting, turn the ON and DIFF trimmers fully clockwise (Trimmer Rotation Angle: 0° - 230°).
2. Turn on the power.
3. <ON pressure setting>
Apply required pressure to the switch. Turn ON trimmer slowly counterclockwise and stop it when LED indicator lights, ON setting obtained.
4. <Differential pressure setting>
Gradually reduce pressure to obtain the required OFF pressure. Then, turn DIFF trimmer counterclockwise slowly and stop it when LED indicator goes off. The OFF setting is now obtained.
5. Make sure if "ON" or "OFF" setting is correct by working of LED indicator when applying or reducing pressure repeatedly several times.

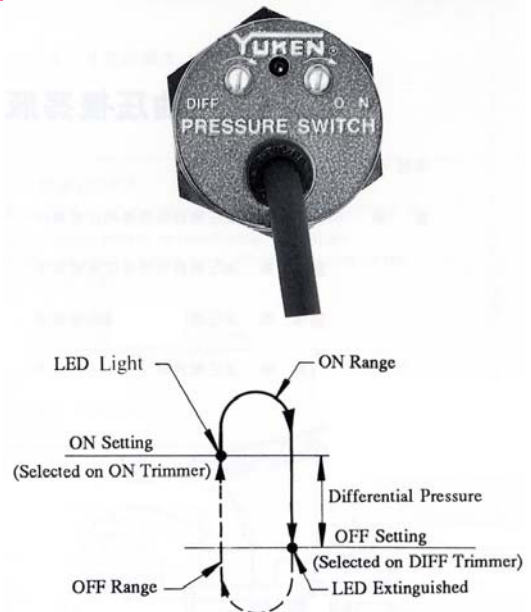

Application Examples of Electrical Circuit

- **Output of Semiconductor Type Pressure Switch (Internal Circuit)**

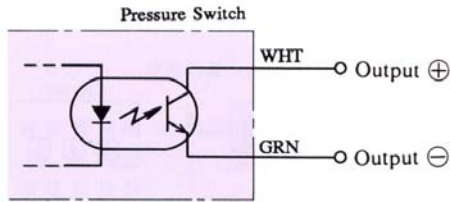

- **Direct Relay Drive**

1. Use relay operable at 100 mA or lower.
2. Connect surge voltage absorption diode (D) in parallel with the relay coil.
3. Connect positive diode (D) between the white and green wires.

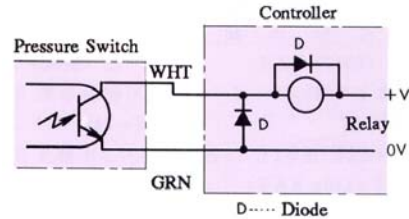

- **Connection to Sequential Controller**

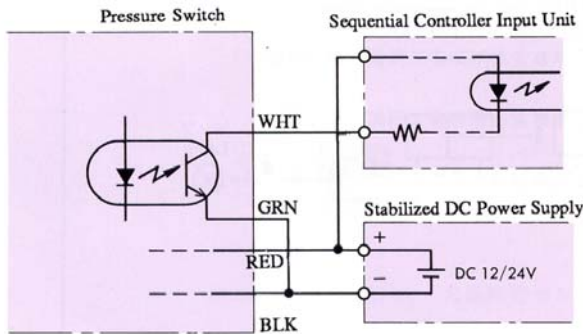

- **The usage below is possible because output circuit is insulated by a photocoupler.**

1. When AND circuit Two Pressures.
The sequential controller is signaled only when pressure switches No. 1 and 2 are both ON.

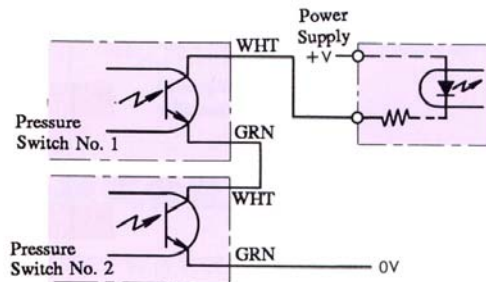

2. When OR circuit two pressures
The sequential controller is signaled when either of pressure switches No. 1 and 2 is ON.

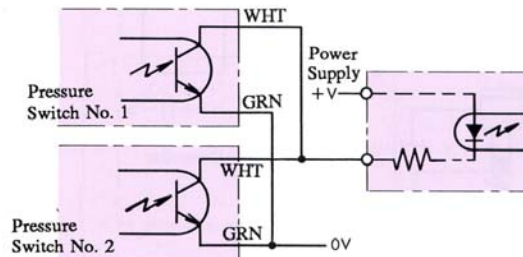

Application Examples

- For hydraulic circuit pressure increase/decrease monitoring or alarming.

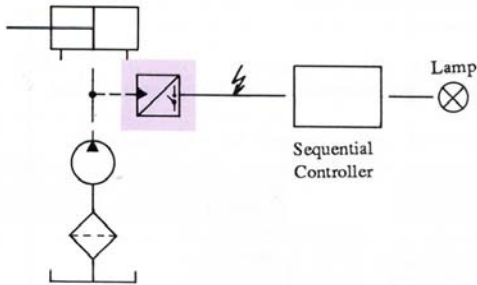

- For fatigue tester or other instrument test counting.

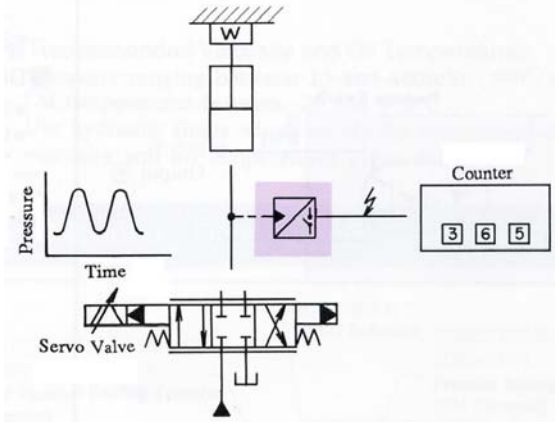

- For actuator stroke completion confirmation or work chuck completion signaling.

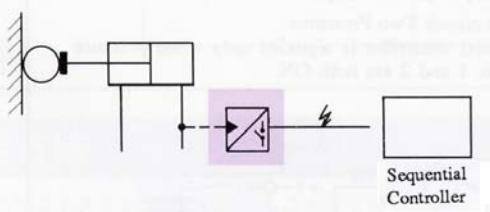

- For simplified measurement. Hydraulic circuit shock pressure can easily be measured (The pressure can be estimated by locating the switch ON point at differing ON settings.)

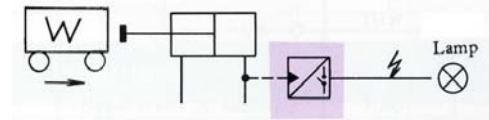

- For accumulator charge control.

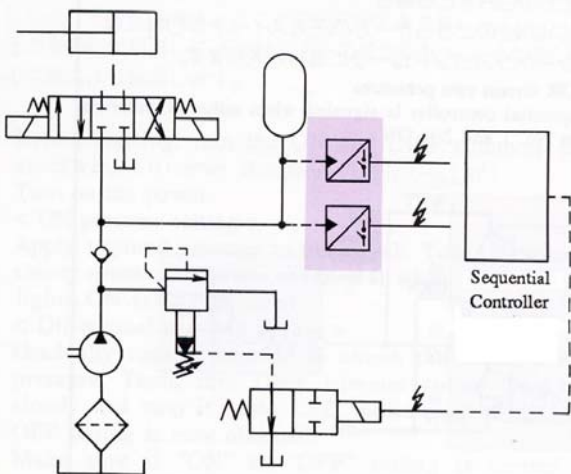

- For use under severe environmental conditions. Operable in places where great vibration occurs or the humidity is high.

