



10 SERIES

MODULAR VALVES

General Information

Mounting Surface : ISO 4401-AF-10-4-A, CETOP-10, NFPA-D10

Up to 25 MPa (3630 PSI), 800 L/m in (211 U.S.GPM)

The modular valves are functional elements with which a hydraulic system can be composed and built easily by stacking them with the mounting bolts. Therefore, no piping is required for the manufacture of the hydraulic systems. Yuken's 10 Series Modular Valves are widely used to compose the hydraulic systems for the various industrial and marine equipment including big machine purpose machines and injection molding machines.

The valves have standardized mounting surface conforming to ISO 4401-AF-10-4-A and optimum thickness for the stacking.



■ Example of Stacking Configuration

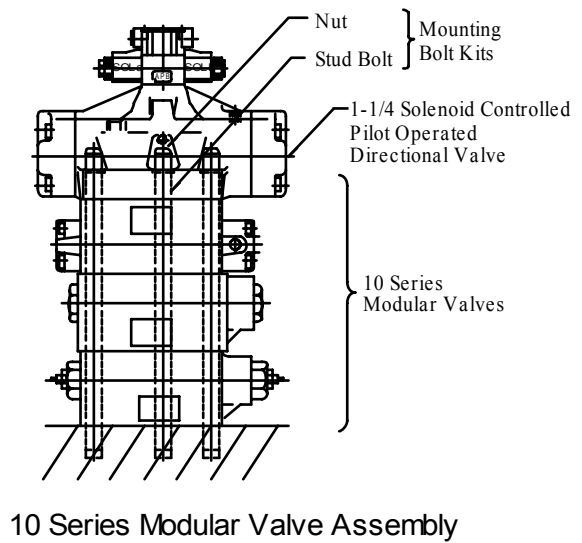
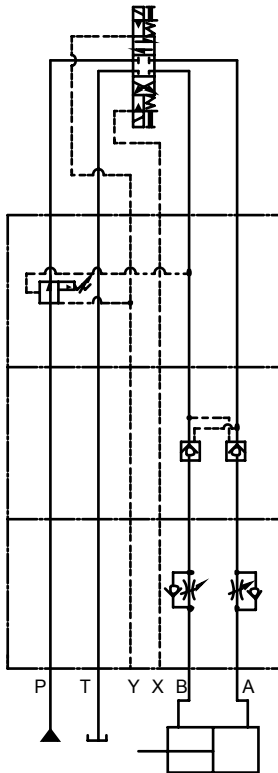

■ Type of Modular Valve

Class	Model Numbers	Graphic Symbols	Page	Class	Model Numbers	Graphic Symbols						Page	
						P	T	Y	X	B	A		
Pressure Control Valves	Solenoid Controlled Pilot Operated Directional Valve (S-)DSHG-10-***-*-42/4290		★2	Directional Control Valves	Pilot Operated Check Valves (for "A-Line", Internal Pilot-Internal Drain Type) MPA-10-*-30/3090						12		
	Reducing Valves (for "P-Line") MRP-10-*-30/3090		6		Pilot Operated Check Valves (for "A-Line", External Pilot-External Drain Type) MPA-10-*-X-30/3090						12		
	Reducing Valves (for "A-Line") MRA-10-*-30/3090		6		Pilot Operated Check Valves (for "A-Line", External Pilot-Internal Drain Type) MPA-10-*-Y-30/3090						12		
	Reducing Valves (for "B-Line") MRB-10-*-30/3090		6		Pilot Operated Check Valves (for "B-Line", Internal Pilot-Internal Drain Type) MPB-10-*-30/3090						12		
Flow Control Valves	Throttle and Check Valves (for "A-Line", Metre-out) MSA-10-X-30/3090		9		Pilot Operated Check Valves (for "B-Line", External Pilot-External Drain Type) MPB-10-*-X-30/3090						12		
	Throttle and Check Valves (for "A-Line", Metre-in) MSA-10-Y-30/3090		9		Pilot Operated Check Valves (for "B-Line", External Pilot-Internal Drain Type) MPB-10-*-Y-30/3090						12		
	Throttle and Check Valves (for "B-Line", Metre-out) MSB-10-X-30/3090		9		Pilot Operated Check Valves (for "A&B-Lines", Internal Pilot-Internal Drain Type) MPW-10-*-30/3090						12		
	Throttle and Check Valves (for "B-Line", Metre-in) MSB-10-Y-30/3090		9		Mounting Bolts	Bolt Kits MBK-10-*-10/1090	—————						16
	Throttle and Check Valves (for "A&B-Lines", Metre-out) MSW-10-X-30/3090		9										
	Throttle and Check Valves (for "A&B-Lines", Metre-in) MSW-10-Y-30/3090		9										

★1. Because drain ports "V" and "W" are not provided for solenoid controlled pilot operated directional valves of Pressure Centred Type (3H*) and models with Pilot Piston (P*), those valves cannot be used in combination with modular valves.

★2. For the details of Solenoid Controlled Pilot Operated Directional Valves, see the following catalogues: Catalogue No. Pub. EC-0404.

■ Instructions

● Caution in the selection of valves and circuit designing

The selection of modular valves, to suit a particular function or hydraulic circuit, are made in exactly the same way as conventional valves, taking into account of the flow and pressure of each valve to be used. In some cases, the stacking system may be restricted, so please refer to the following instructions for stacking sequence. Please note, that when designing a system using modular stacking valves, due consideration should be given to working space for future maintenance.

● Stacking sequence when using reducing valves (for "A" or "B" line) and pilot operated check valves

Because reducing valves are spool type, there is an internal leakage. In the stacking sequence shown in the drawing left (incorrect), the cylinder moves due to leakage through the pilot pressure line

Consequently, retaining the position of the cylinder using a pilot operated check valve becomes impossible. The stacking sequence shown in the drawing right (correct) is required in order to retain the cylinder position.

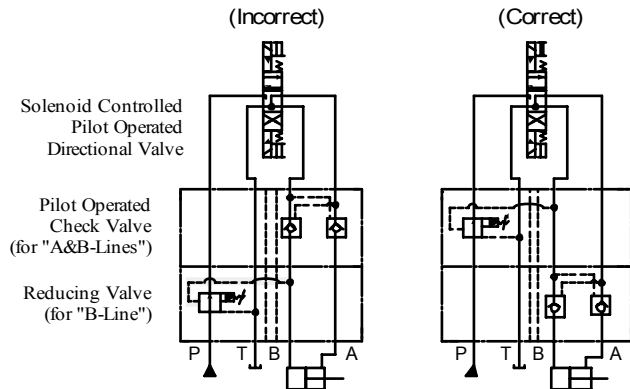

● Stacking sequence when using reducing valves (for "A" or "B" line) and throttle and check valves (for metre-out)

In B to T flow in the drawing left (incorrect), pressure is generated at part with a throttle effect of the throttle and check valve. Depending upon the pressure so generated, the reducing valve may perform a pressure reducing function which causes a shortage of output power of the cylinder and spoils the smooth operation of the cylinder. Therefore, stacking sequence in the drawing right (correct) is required in this combination.

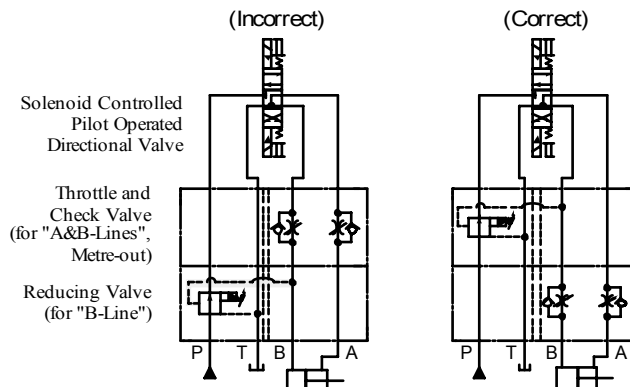

● Stacking sequence when using pilot operated check valves and throttle and check valves (metre-out)

In A to T flow in the drawing left (incorrect), pressure is generated at part with a throttle effect of the throttle and check valve.

The pressure so generated acts to shut the pilot operated check valve and eventually creates an open and shut operation of the valve repeatedly which may cause the cylinder to have a knocking effect (the same effect will occur in the case of B to T flow). Therefore, the stacking sequence in the drawing right (correct) is required in this combination.

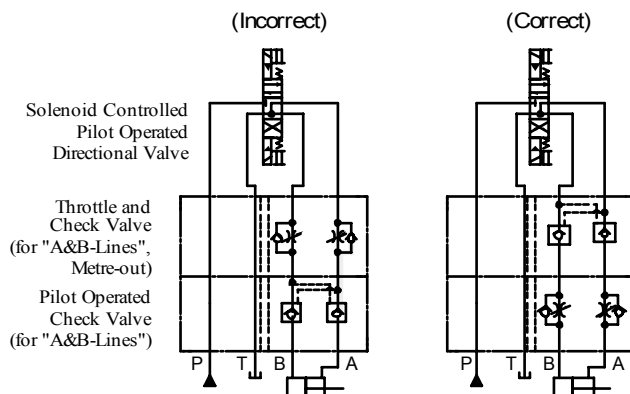

■ Specifications

Max. Operating Pressure.....25 MPa (3630 PSI)
 Max. Flow Rate800 L/min (211 U.S. GPM)
 Number of Stack1 to 5 stacks*

★ The number of stacks includes the Solenoid Controlled Pilot Operated Directional Valve.

1-1/4 Solenoid Controlled Pilot Operated Directional

YUKEN 10 SERIES MODULAR VALVES are designed for use with solenoid controlled pilot operated directional valve having an ISO 4401-AF-10-4-A (CETOP-10, NFPA-D10) interface such as YUKEN's DSHG-10. Please refer to the Catalogue No. Pub. EC-0404 for details.

■ Hydraulic Fluids

● Fluid Types

Any type of hydraulic fluid listed in the table below can be used.

Petroleum base oils	Use fluids equivalent to ISO VG 32 or VG 46.
Synthetic fluids	Use phosphate ester or polyol ester fluid. When phosphate ester fluid is used, prefix "F-" to the model number because the special seals (fluororubber) are required to be used.
Water containing fluids	Use water-glycol fluid.

Note: For use with hydraulic fluids other than those listed above, please consult your Yuken representatives in advance.

● Recommended Viscosity and Temperatures

Always be sure to use hydraulic fluids within the stipulated conditions shown below:

Viscosity: 15 to 400 mm²/s (77 to 1800 SSU), Temperature: -15 to +70°C (5 to 160°F)

● Control of Contamination

Due caution must be paid to maintaining control over contamination of the hydraulic fluids which may otherwise lead to breakdowns and shorten the life of the valve. Please maintain the degree of contamination within NAS 1638-Grade 12. Use 25 μm or finer line filter.

■ Sub-plates

When mounting the modular valves, use sub-plates specified below. If these sub-plates are not used, ensure that the mounting surface has a good machined finish.

Sub-plate Model Numbers: DHGM-10*-40/4080/4090

Note: For the details of Sub-plate, see the following catalogues: Catalogue No. Pub. EC-0404

■ Mounting Bolts

10 Series modular valves are mounted using stud bolts which are supplied in a kit form. When mounting, see the following table for tightening torque. After the test run, be sure to tighten again firmly with the specified torque.

Bolt Kit Model Numbers	Tightening torque Nm (in. lbs.)
MBK-10-*-10 MBK-10-*-1090	150-170 (1330-1505)

■ Assembly

Assembly should be carried out in clean conditions and in accordance with the following procedure. Cautious attention should be paid to ensure that the interface of the valves are clean and free from dirt or other foreign materials.

● Assembly Procedure:

- 1) Screw-in the six stud bolts, fully into the tapped holes on the mounting surface of the specified sub-plate or manifold.
- 2) Referring to the circuit diagram, stack the modular valve and the solenoid controlled pilot operated directional valve. Take care to face their o-ring side to the base plate, put the stud bolts in position and be sure to check that the locating pins are at the pin holes.
- 3) Align both the end of the valves stacked.
- 4) Screw-in the six nuts onto the stud bolts and tighten with the specified torque. After the test run, be sure to re-tighten the nuts firmly with the specified torque.

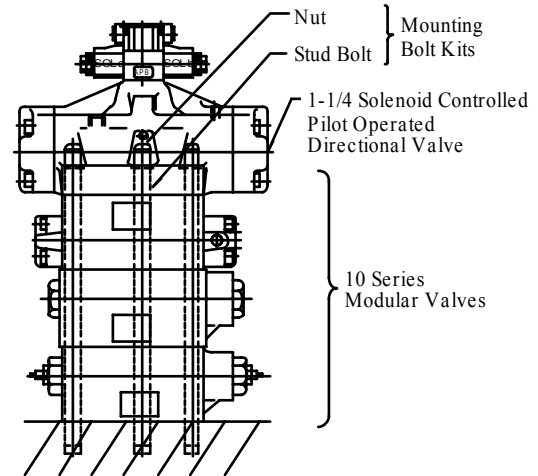

[Example] 10 Series Modular Valves

⚠ CAUTION

- Keep all installation holes and surface clean. Failure to do this may cause fire due to oil leakage.
- Before installing the product, be sure that all specified bolts are tightened to the specified torque levels. Tightening to levels outside specifications may cause improper operation, damage, oil leakage, etc.

■ Pressure Drop

Pressure drop curves of the modular valves are those based on viscosity of 35 mm²/s (164 SSU) and specific gravity of 0.850.

When using the modular valves in conditions other than the above mentioned, find the appropriate values referring to the following table and formula.

- For any other viscosity, multiply the factors in the table below.

Viscosity	mm ² /s	15	20	30	40	50	60	70	80	90	100
	SSU		77	98	141	186	232	278	324	371	417
Factor		0.81	0.87	0.96	1.03	1.09	1.14	1.19	1.23	1.27	1.30

- For any other specific gravity (G'), the pressure drop (ΔP') may be obtained from the following formula.

$$\Delta P' = \Delta P (G'/0.850)$$



1-1/4, Reducing Valves

For "P" Line: MRP-10-* -30/3090
 For "A" Line: MRA-10-* -30/3090
 For "B" Line: MRB-10-* -30/3090

MODULAR VALVES

Specifications / Others

Specifications

Model Numbers	Max. Operating Pressure MPa (PSI)	Max. Flow * L/min (U.S.GPM)
MR*-10-A-30/3090	25 (3630)	250 (66)
B		800 (211)
MR*-10-C-30/3090 H		

★ In the pressure adjustment ranges "A" and "B", maximum flow rates are limited by the pressure setting on the secondary side. Referring to the secondary pressure vs maximum flow characteristics on the following page, use the valve at the maximum flow rate within a zone highlighted with .

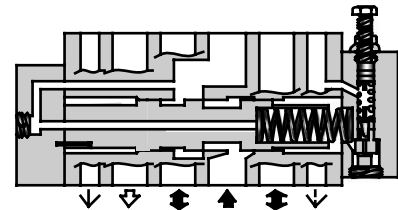

Model Number Designation

F-	MRP	-10	-B	-30	*
Special Seals	Series Number	Valve Size	Pres. Adj. Range MPa (PSI)	Design Number	Design Standard
F: Special Seals for Phosphate Ester Type Fluids (Omit if not required)	MRP: Reducing Valve for P-Line MRA: Reducing Valve for A-Line MRB: Reducing Valve for B-Line	10	A: 0.7-7 (100-1020) B: 1.5-7 (220-1020) C: 3.5-14 (510-2030) H: 7-21 (1020-3050)	30	Refer to ★

★ Design Standards: None Japanese Standard "JIS" and European Design Standard
 90 N. American Design Standard

Instructions

- Connect **Drain Line (Y port)** to oil tank independently so as to obtain stable pressure setting. At the same time, the solenoid controlled pilot operated directional valve to be used in combination with this valve must be of internal drain type (with T).
- To make pressure adjustment, loosen the lock nut and turn the pressure adjustment screw clockwise or anti-clockwise. For an increase of pressure, turn the screw clockwise. Be sure to re-tighten the lock nut firmly after making adjustment to the pressure.

Graphic Symbols

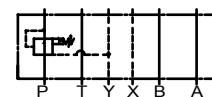

MRP-10

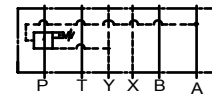

MRA-10

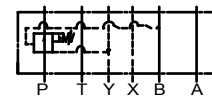

MRB-10

Hydraulic Fluid: Viscosity 35 mm²/s (164 SSU), Specific Gravity 0.850

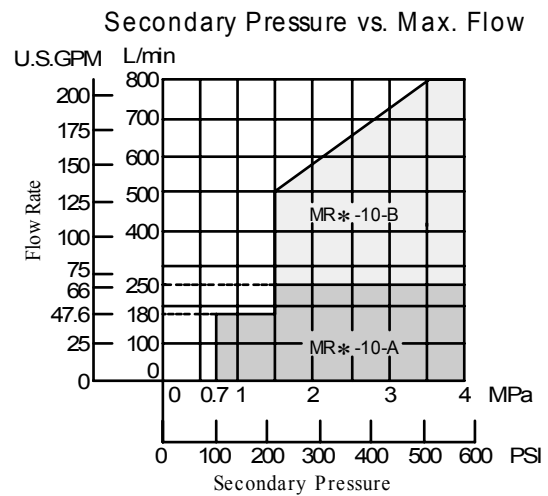
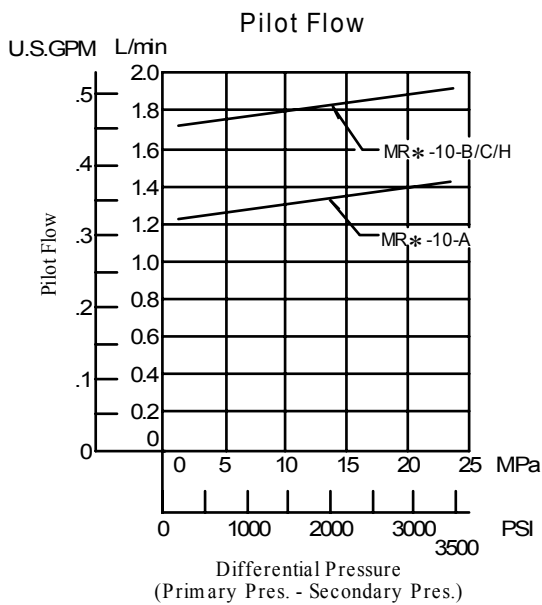
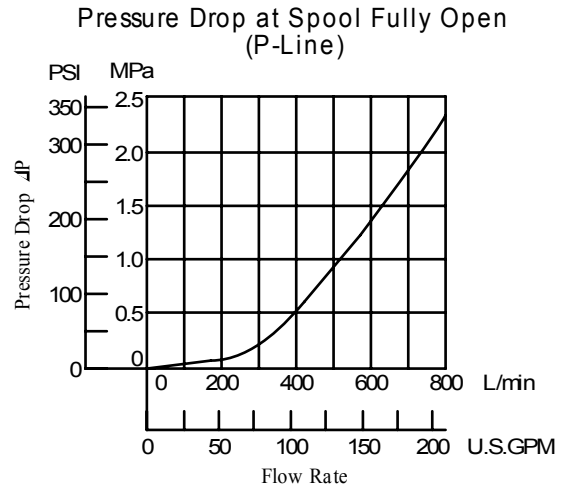
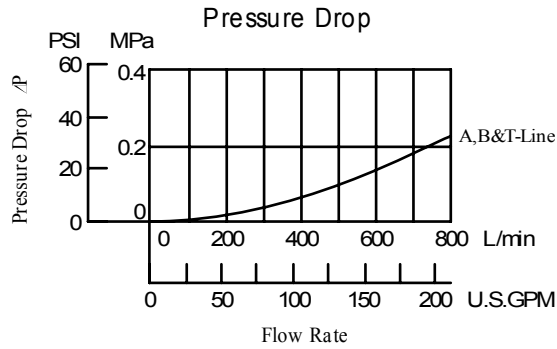

MRP-10-* -30/3090

MRA-10-* -30/3090

MRB-10-* -30/3090

DIMENSIONS IN
MILLIMETRES (INCHES)

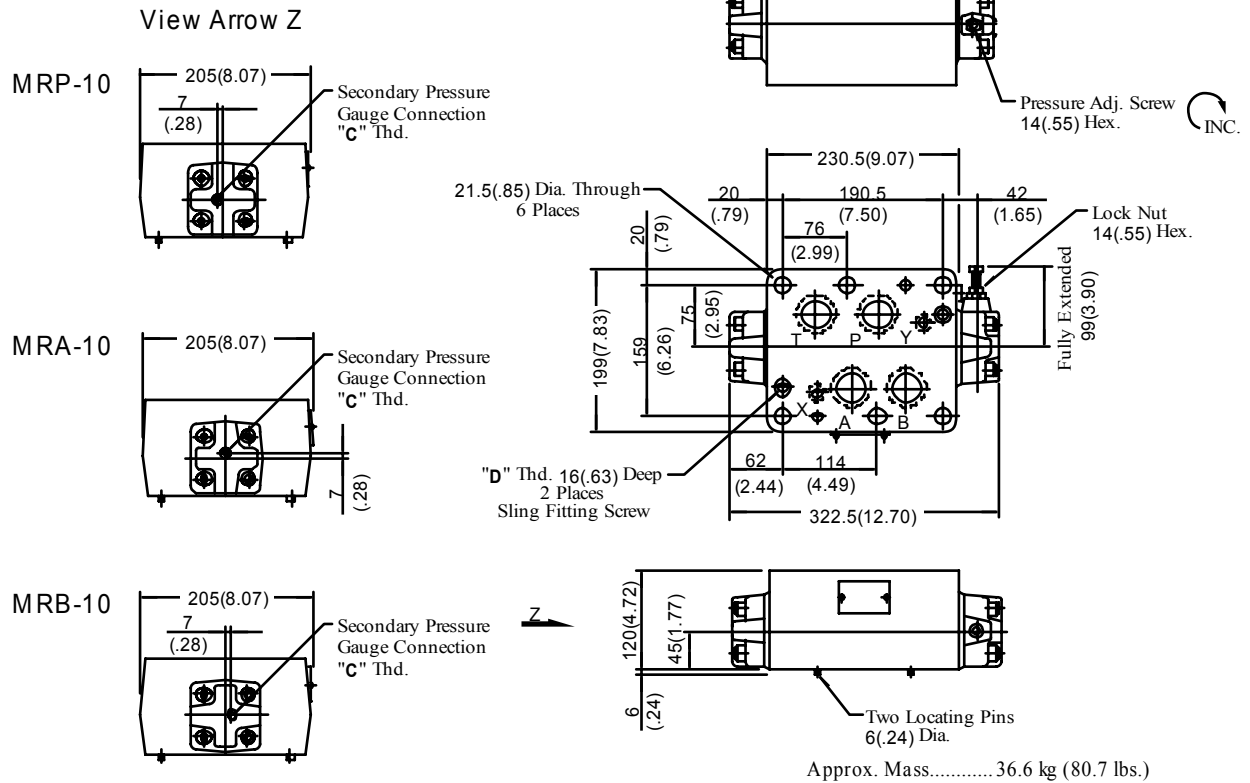

Approx. Mass..... 36.6 kg (80.7 lbs.)

Model Numbers	Thread Size	
	"C" Thd.	"D" Thd.
MR*-10-* -30	Rc 1/4 = 1/4 BSP.Tr	M8
MR*-10-* -3090	1/4 NPT	5/16-18 UNC

■ Spare Parts List

MRP-10-* -30/3090

MRA-10-* -30/3090

MRB-10-* -30/3090

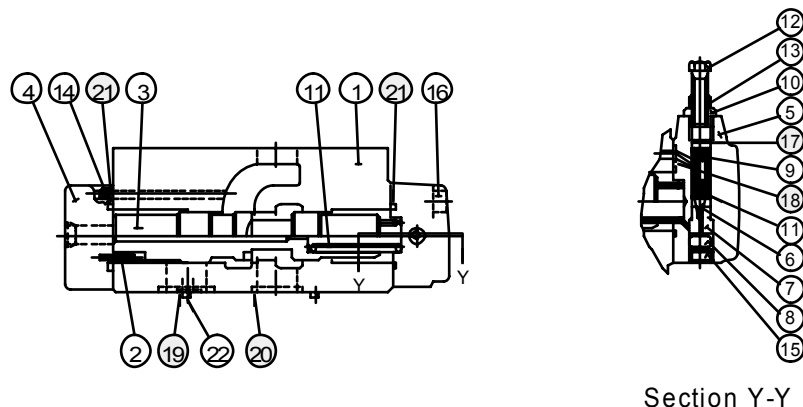

Section Y-Y

● List of Seals

Item	Name of Parts	Part Numbers	Qty.	Remarks
17	O-Ring	SO-NA-P9	1	Included in Seal Kit Kit No.: KS-MRP-10-10
18	O-Ring	SO-NB-P9	4	
19	O-Ring	SO-NB-P16	2	
20	O-Ring	SO-NB-P40	4	
21	O-Ring	SO-NB-P44	2	

⚠ CAUTION

When making replacement of seals, please do it carefully after reading through the relevant instructions in the Operator's Manual.

1-1/4, Throttle and Check Valves

For "A" Line: MSA-10-* -30/3090

For "B" Line: MSB-10-* -30/3090

For "A&B" Lines: MSW-10-* -30/3090

Specifications / Others

Specifications

Model Numbers	Max. Operating Pressure MPa (PSI)	Max. Flow L/min (U.S.GPM)
MSA-10-* -30/3090 MSB-10-* -30/3090 MSW-10-* -30/3090	25 (3630)	800 (211)

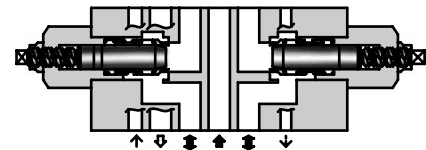

Model Number Designation

F-	MSW	-10	-X	-30	*
Special Seals	Series Number	Valve Size	Direction of Flow	Design Number	Design Standard
F: Special Seals for Phosphate Ester Type Fluids (Omit if not required)	MSA : Throttle and Check Valves for A-Line MSB : Throttle and Check Valves for B-Line MSW : Throttle and Check Valves for A&B-Lines	10	X: Metre-out Y: Metre-in	30	Refer to ★

★ Design Standards: None Japanese Standard "JIS" and European Design Standard 90 N. American Design Standard

Instructions

- To make flow rate adjustment, loosen the lock nut and turn the flow adjustment screw clockwise or anti-clockwise. To throttle the flow, turn the screw clockwise. Be sure to re-tighten the lock nut firmly after the adjustment of the flow rate is completed.

Graphic Symbols

Metre-out	Metre-in
<p>MSA-10-X</p>	<p>MSA-10-Y</p>
<p>MSB-10-X</p>	<p>MSB-10-Y</p>
<p>MSW-10-X</p>	<p>MSW-10-Y</p>



Hydraulic Fluid: Viscosity 35 mm²/s (164 SSU), Specific Gravity 0.850

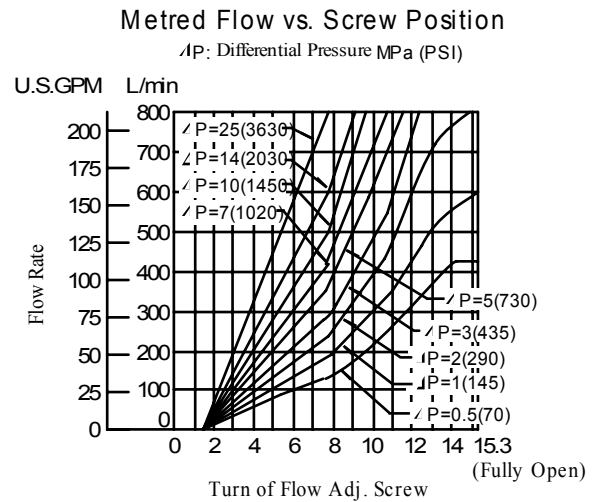
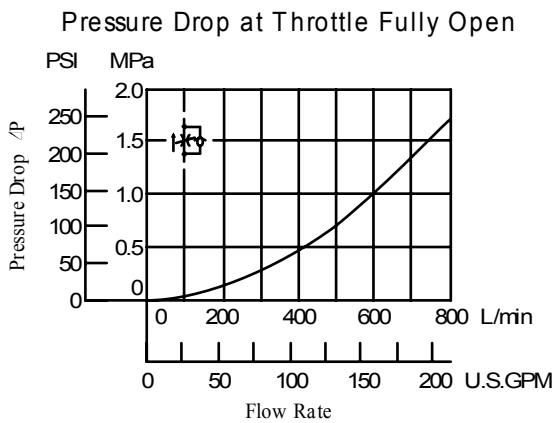
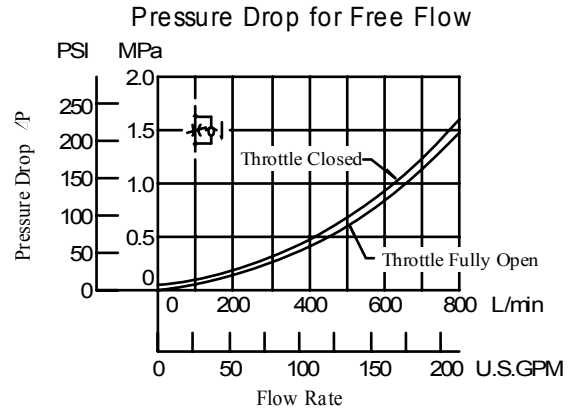
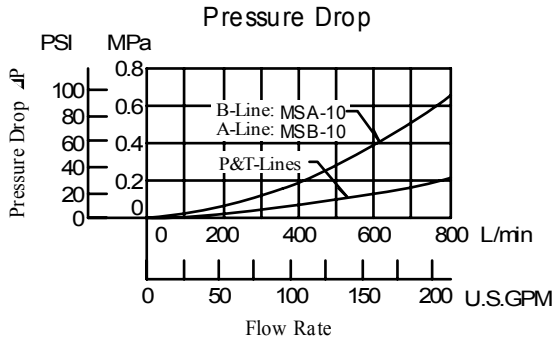

MSW-10- X30/3090
Y

DIMENSIONS IN
MILLIMETRES (INCHES)

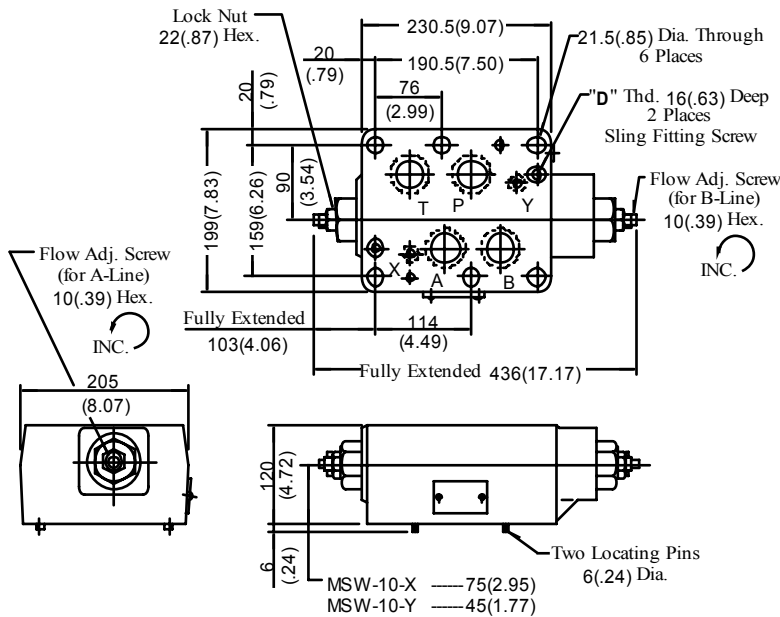

Model Numbers	"D" Thd.
MS*-10-*-30	M8
MS*-10-*-3090	5/16-18 UNC

Approx. Mass.....35.7 kg (78.7 lbs.)

MSA-10- X30/3090
Y

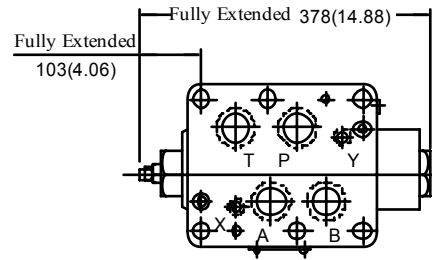

Approx. Mass..... 35 kg (77.2 lbs.)

• For other dimensions, refer to "MSW-10" drawing left.

MSB-10- X30/3090
Y

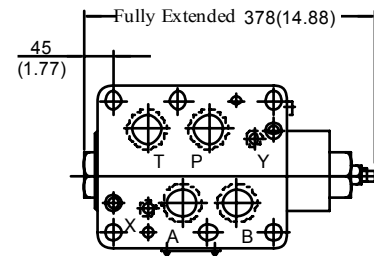

Approx. Mass..... 35 kg (77.2 lbs.)

• For other dimensions, refer to "MSW-10" drawing left.

■ Spare Parts List

MSA-10-*-30/3090

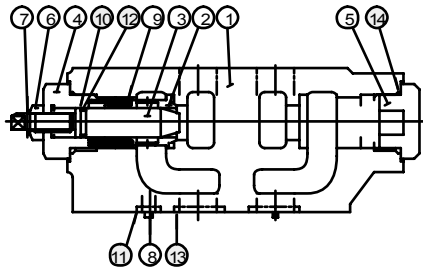

MSB-10-*-30/3090

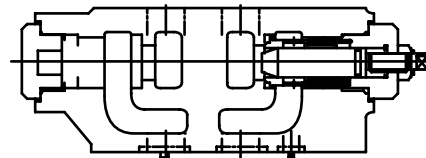

MSW-10-*-30/3090

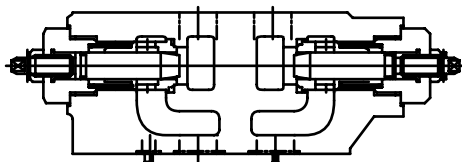

⚠ CAUTION

When making replacement of seals, please do it carefully after reading through the relevant instructions in the Operator's Manual.

● List of Seals

Item	Name of Parts	Part Numbers	Quantity		
			MSA-10	MSB-10	MSW-10
10	Back Up Ring	SO-BB-P20	1	1	2
11	O-Ring	SO-NB-P16	2	2	2
12	O-Ring	SO-NA-P20	1	1	2
13	O-Ring	SO-NB-P40	4	4	4
14	O-Ring	SO-NB-P44	2	2	2

Note: When ordering seals, please specify the seal kit number from the table right.

● List of Seal Kits

Model Numbers	Seal Kit Numbers
MSA-10	KS-MSA-10-10
MSB-10	
MSW-10	KS-MSW-10-10

Specifications / Others

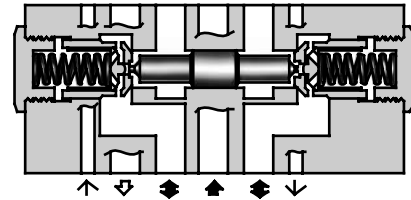

Specifications

Model Numbers	Max. Operating Pressure MPa (PSI)	Max. Flow L/min (U.S.GPM)
MPA-10*-*-30/3090 MPB-10*-*-30/3090 MPW-10*-*-30/3090	25 (3630)	800 (211)

Model Number Designation

F-	MPA	-10	S	-2	-X	-30	*
Special Seals	Series Number	Valve Size	Port Tapping Feature of Pilot-Drain Port ^{★1}	Cracking Pressure MPa (PSI)	Pilot-Drain ^{★2} Connection	Design Number	Design Standard
F: Special Seals for Phosphate Ester Type Fluids (Omit if not required)	MPA: Pilot Operated Check Valve for A-Line MPB: Pilot Operated Check Valve for B-Line MPW: Pilot Operated Check Valve for A&B-Lines	10	None: Taper Thread S: Straight Thread (Applicable only for Japanese Std. "JIS")	2: 0.2 (29) 4: 0.4 (58)	None: Internal Pilot-Internal Drain X: External Pilot-External Drain Y: External Pilot-Internal Drain	30	Refer to ^{★3}

- ★ 1. This item applies only to External Pilot or External Drain Type.
- ★ 2. Only "None: Internal Pilot-Internal Drain Type" is available for MPW (for "A&B-Lines").
- ★ 3. Design Standards: None Japanese Standard "JIS" and European Design Standard
 90 N. American Design Standard

Graphic Symbols

Pilot-Drain type / Model No.	Internal pilot-Internal drain type	External pilot-External drain type	External pilot-Internal drain type
MPA-10	 MPA-10-*	 MPA-10*-*-X	 MPA-10*-*-Y
MPB-10	 MPB-10-*	 MPB-10*-*-X	 MPB-10*-*-Y
MPW-10	 MPW-10-*	—	—

Hydraulic Fluid: Viscosity 35 mm²/s (164 SSU), Specific Gravity 0.850

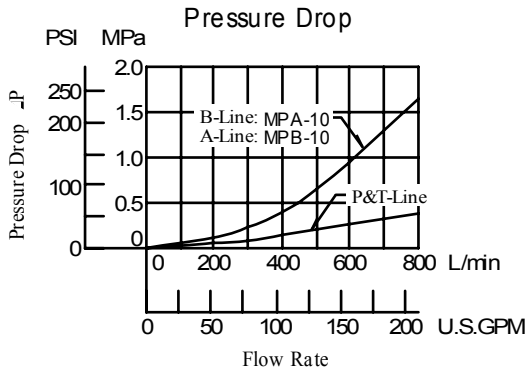

Pressure Drop for Reversed Controlled Flow

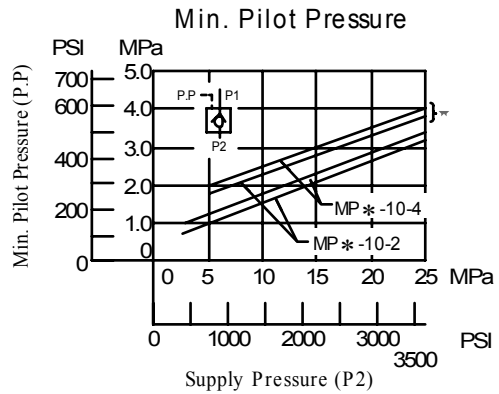
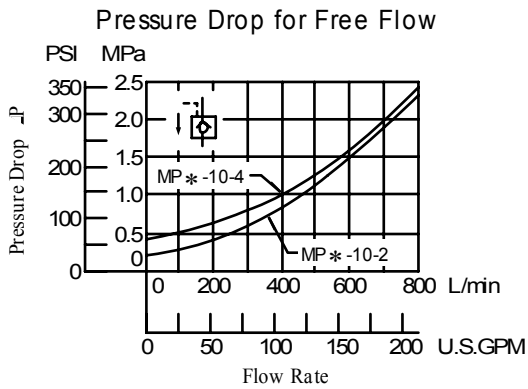
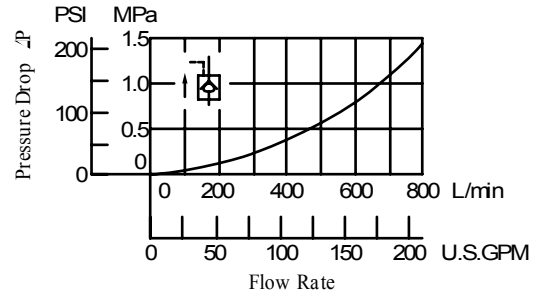

★ In case of 500 L/min (132 U.S.GPM) or more.



Installation Drawing

MPA-10*-*-30/3090 (Internal pilot-
Internal drain type)
MPB-10*-*-30/3090 (Internal drain type)
MPW-10*-*-30/3090

**DIMENSIONS IN
MILLIMETRES (INCHES)**

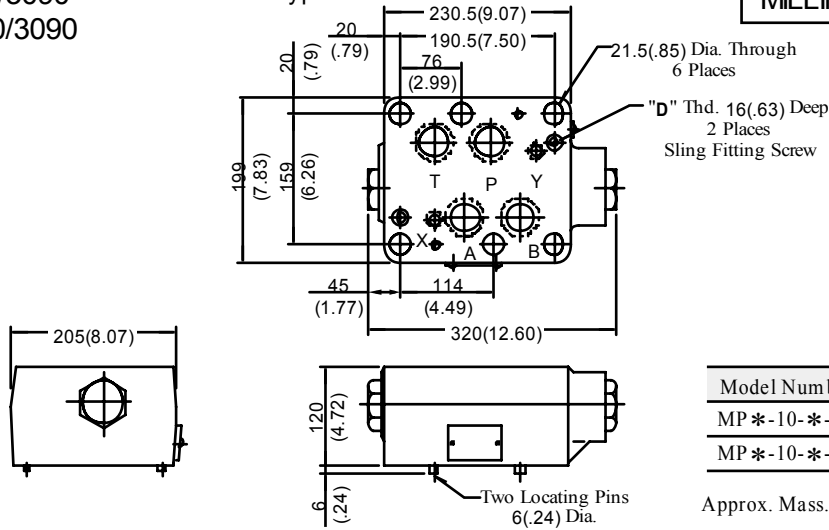

Model Numbers	"D" Thd.
MP*-10*-30	M8
MP*-10*-3090	5/16-18 UNC

Approx. Mass.....36.5 kg (80.5 lbs.)

MPA-10*-*-X-30/3090 (External pilot-
External drain type)

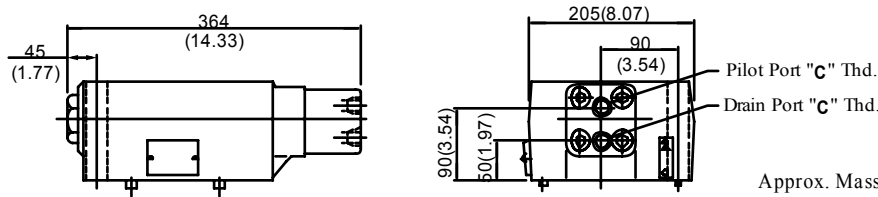

Approx. Mass.....38 kg (83.8 lbs.)

MPA-10*-*-Y-30/3090 (External pilot-
Internal drain type)

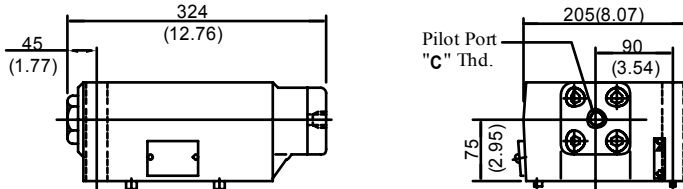

Approx. Mass.....36.5 kg (80.5 lbs.)

• For other dimensions, refer to "Internal pilot-Internal drain type" drawing above.

MPB-10*-*-X-30/3090 (External pilot-
External drain type)

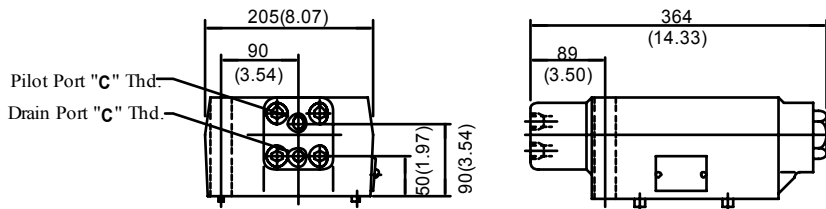

Model Numbers	Piping Size "C" Thd.
MP ^A _B -10*-*-30	Rc 3/8 = 3/8 BSP. Tr
MP ^A _B -10*-*-3090	3/8 NPT
MP ^A _B -10S*-*-30	G 3/8

Approx. Mass.....38 kg (83.8 lbs.)

MPB-10*-*-Y-30/3090 (External pilot-
Internal drain type)

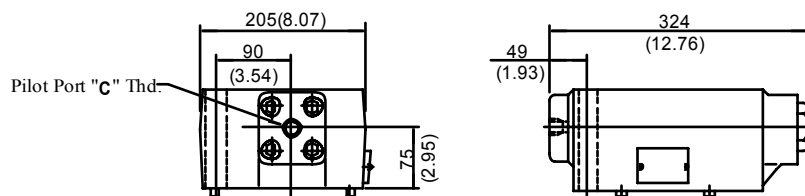

Approx. Mass.....36.5 kg (80.4 lbs.)

• For other dimensions, refer to "Internal pilot-Internal drain type" drawing above.

■ Spare Parts List

⚠ CAUTION

When making replacement of seals, please do it carefully after reading through the relevant instructions in the Operator's Manual.

Internal pilot- Internal drain type

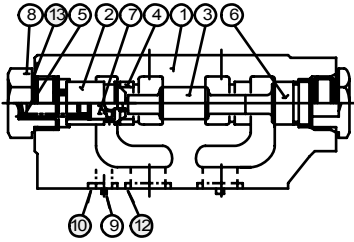

MPA-10*-30/3090

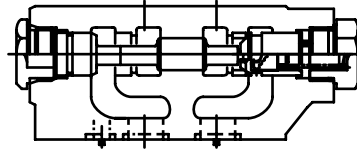

MPB-10*-30/3090

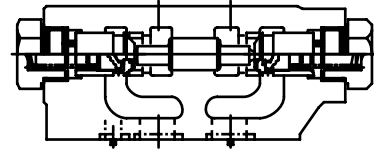

MPW-10*-30/3090

External pilot- External drain type

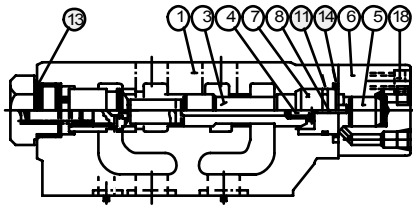

MPA-10*-*-X-30/3090

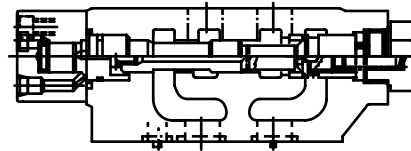

MPB-10*-*-X-30/3090

External pilot- External drain type

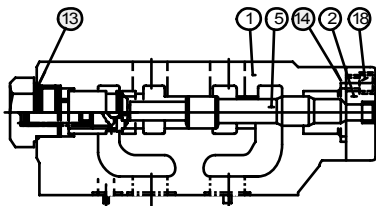

MPA-10*-*-Y-30/3090

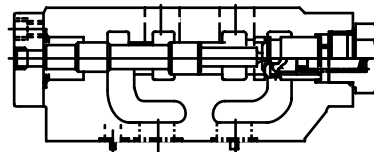

MPB-10*-*-Y-30/3090

● List of Seals

Item	Name of Parts	Part Numbers	Quantity		
			Internal Pilot- Internal Drain	External Pilot- External Drain	External Pilot- Internal Drain
10	O-Ring	SO-NB-P16	2	2	2
11	O-Ring	SO-NB-P34	—	1	—
12	O-Ring	SO-NB-P40	4	4	4
13	O-Ring	SO-NB-P44	2	1	1
14	O-Ring	SO-NB-P46	—	1	1

Note: When ordering seals, please specify the seal kit number from the table right.

● List of Seal Kits

Model Numbers	Seal Kit Numbers
MPA-10	KS-MPA-10-10
MPB-10	
MPW-10	
MPA-10*-*-X	KS-MPA-10-X-10
MPB-10*-*-X	
MPA-10*-*-Y	KS-MPA-10-Y-10
MPB-10*-*-Y	

F

Valves are mounted with six stud bolts. Valve combination varies according to the circuit type. Hence, the mounting bolt kits are available on a combination type basis. When ordering the mounting bolt kit, be sure to give the bolt kit model number from the table below.



Model Number Designation

MBK	-10	-04	-10	*
Series Number	Size of Modular Valve	Bolt Number	Design Number	Design Standard
MBK: Mounting Bolt Kits for Modular Valves	10	01, 02, 03, 04	10	None: Japanese Standard "JIS" and European Design Standard 90: N.American Design Standard

Bolt Kits Selection Chart

Model Numbers	Quantity of Valves to be Stacked		Approx. Mass kg (lbs.)
	Sol. Cont. Pilot Operated Directional Valves (DSHG-10)	Modular Valve	
MBK-10-01-10*	1	1	3.9 (8.6)
MBK-10-02-10*	1	2	5.7(12.6)
MBK-10-03-10*	1	3	7.4(16.3)
MBK-10-04-10*	1	4	9.2(20.3)

Bolt Kit Composition

Stud Bolt----- 6 Pcs. } 1 set
Nut----- 6 } 1 set

Tightening Torque:

150-170 Nm (1330-1505 in. lbs.)

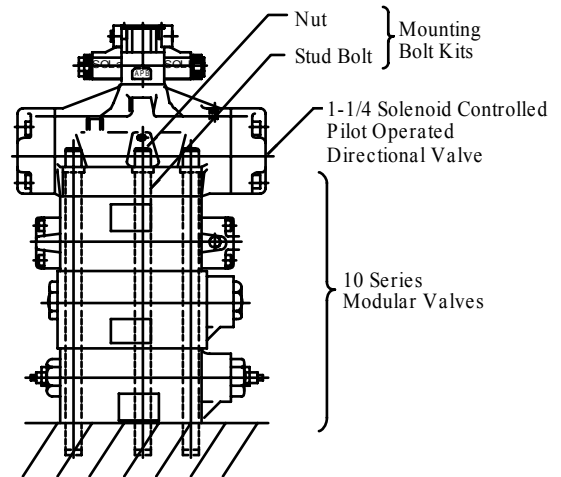

10 Series Modular Valve Assembly

MBK-10-* -10/1090

DIMENSIONS IN
MILLIMETRES (INCHES)

Stud Bolt

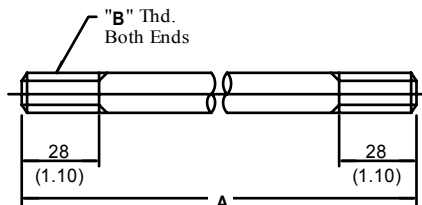

Nut

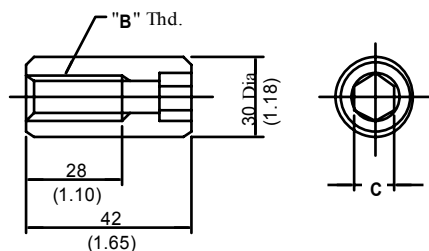

Bolt Numbers	A mm (in.)
MBK-10-01	217 (8.54)
MBK-10-02	337 (13.27)
MBK-10-03	457 (17.99)
MBK-10-04	577 (22.72)

Model Numbers	"B" Thd.	C
MBK-10-* -10	M20	17 (.67)
MBK-10-* -1090	3/4-10 UNC	15.9 (5/8)

When mounting 10 series modular valve, be sure to use a sub-plate for 1-1/4 solenoid controlled pilot operated directional valves.

Name	Sub-plate Model Number	Catalogue No.
Sub-plate for 1-1/4 Solenoid Controlled Pilot Operated Directional Valves	DHGM-10*-40/4080/4090	Pub. EC-0404

When no sub-plates are used, be sure to use the following mounting surface.

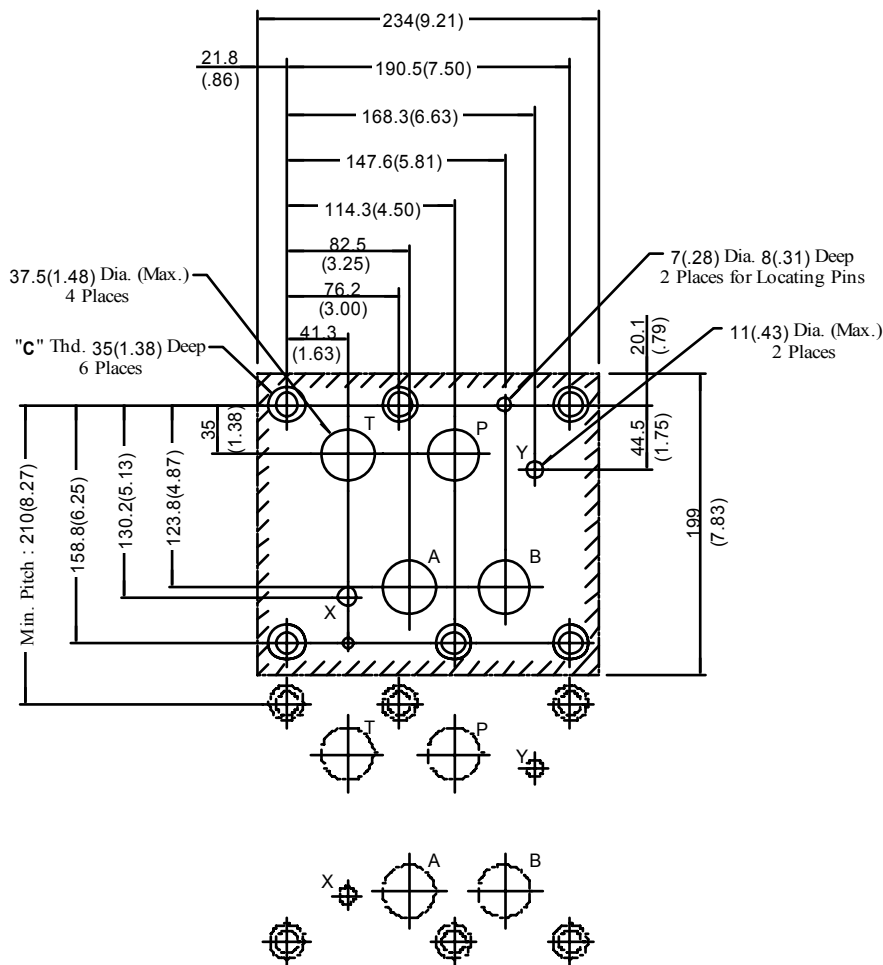

Design Std.	"C" Thd.
Japanese Std. "JIS" and European Design Std.	M20
N. American Design Std.	3/4-10 UNC

