



"AR" SERIES PISTON PUMPS

Variable Displacement-Single Pumps
Pressure Compensator Type, AR16 / AR22-
FR01

PISTON
PUMPS



Up to 16 MPa (2320 PSI), 22.2 cm³/rev (1.35 CU.IN./rev)

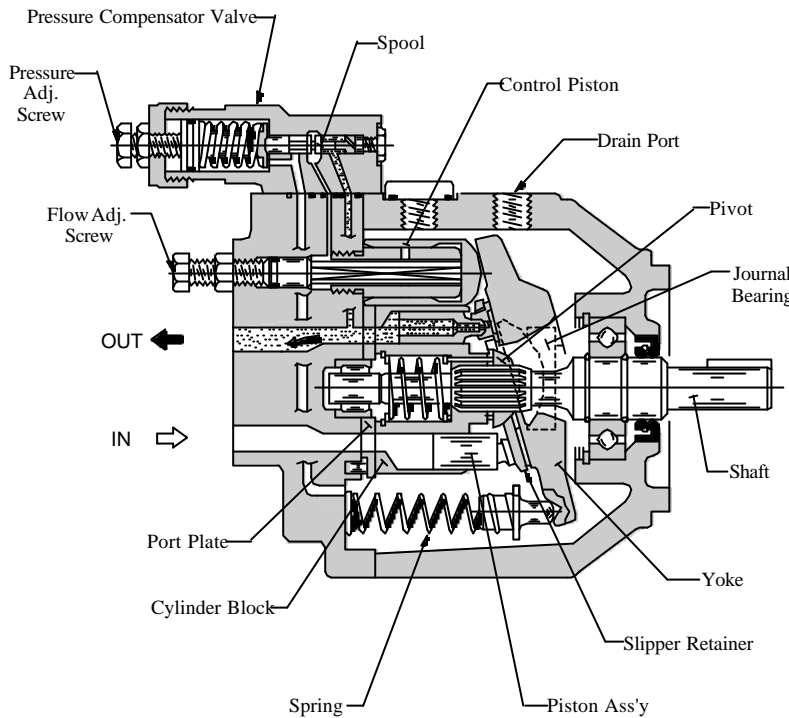

Graphic Symbol

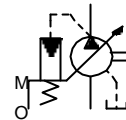

■ Features

■ Smaller in Size and Lighter in Mass

As indicated in the dimensional comparison presented below, the AR16 is smaller than the A16 (32 design). Also, the mass of AR16 is substantially lighter than the A16.

■ Low Noise

The noise level of AR16 has been reduced by 1-2 dB (A) at full flow and full cut-off compared with that of the excellent A16 quiet pump.

[Comparison of "AR16" with "A16"]

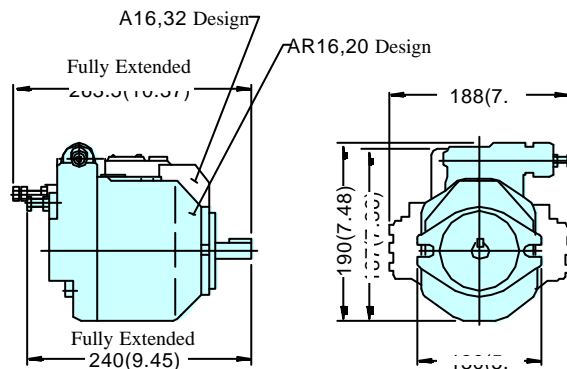

DIMENSIONS IN
MILLIMETRES (INCHES)

Model	Approx. Mass (Flange Mtg.)	Ratio of Mass (AR16/A16)
AR16	9.8 kg (21.6 lbs.)	60 %
A16	16.5 kg (36.4 lbs.)	

Instructions

1. Hydraulic Fluids

Use petroleum base oils such as anti-wear type hydraulic oils or R & O (Rust and Oxidation inhibitor) type hydraulic oils equivalent to ISO VG-32 or 46. The recommended viscosity range is from 20 to 400 mm²/s (98 to 1800 SSU) and temperature range is from 0 to 60°C (32 to 140°F), both of which have to be satisfied for the use of the above hydraulic oils.

2. Control of Contamination

Due caution must be paid to maintaining control over contamination of the operating oil which can otherwise lead to breakdowns and shorten the life of the unit. Please maintain the degree of contamination within NAS Grade 10.

The suction port must be equipped with at least a 100 μm (150 mesh) reservoir type filter and the return line must have a line filter of under 10 μm.

3. Mounting

When installing the pump the filling port should be positioned upwards.

4. Alignment of Shaft

Employ a flexible coupling whenever possible, and avoid any stress from bending or thrust.

Maximum permissible misalignment is less than 0.1 mm (.004 inches) TIR and maximum permissible misangular is less than 0.2°.

5. Suction Pressure

Permissible suction pressure at inlet port of the pump is between -16 and +50 kPa (5 in.Hg Vacuum and 7 PSIG).

For piping to the suction port, use the pipes of the same diameter as that of the specified pipe flange to be used. Make sure that the height of the pump suction port is within one metre (3.3 ft) from the oil level in the reservoir.

6. Hints on Piping

When using steel pipes for the suction or discharge ports, excessive load from the piping to the pump generates excessive noise.

Whenever there is fear of excessive load, please use rubber hoses.

7. Suction Piping

In case the pump is installed above the oil level, the suction piping and suction line filter should be located lower than the pump position to prevent air in the suction line.

8. Drain Piping

Install drain piping according to the chart and ensure that pressure within the pump housing should be maintained at a normal pressure of less than 0.1 MPa (14.5 PSI) and surge pressure of less than 0.5 MPa (72.5 PSI).

Length of piping should be less than 1 m (3.3 ft.), and the pipe end should be submerged in oil.

In case AR16 and AR22 pump, a screw-in torque of fitting is 40 to 50 Nm (354 to 443 IN.lbs.). Do not apply bending and thrust torque to the fitting.

[Recommended Drain Piping Size]

Model	Fitting Size	Inside Dia. of Pipe
AR16, AR22	3/8 [Inside Dia. 8.5 mm (.33 in.) or more]	10 mm (.39 in.)

9. Bleeding Air

It may be necessary to bleed air from pump case and outlet line to remove causes of vibration. An air bleed valve (Model No. ST1004-* -10*, Catalogue No.: Pub. EC-3001) is recommended for this purpose.

10. Starting

Before first starting, fill pump case with clean operating oil via the fill port.

In order to avoid air blockage when first starting, adjust the control valves so that the discharged oil from the pump is returned direct to the tank or the actuator moves in a free load.

[Volume of Pre-fill Oil Required]

Model	Volume cm ³ (in. ³)
AR16 AR22	430 (26.2)

11. Setting Discharge Pressure and Delivery

At the time of shipment, the unit has been preset to maximum delivery and minimum discharge pressure

Adjust the preset delivery and pressure to meet your system requirements.

■ Adjustment of Discharge Pressure

Turning the adjustment screw clockwise, increases pressure.

[Volume adjusted by each full turn of the pressure adjustment screw]

Model Numbers	Adjustment Volume MPa (PSI)
AR16/AR22-FR01B	2.9 (420)
AR16/AR22-FR01C	5.4 (780)

■ Adjustment of Delivery

Turning the delivery adjustment screw clockwise, decreases delivery.

[The minimum adjustable flow and adjustable volume of each full turn of the delivery adjustment screw]

Model Numbers	Adjustable volume with each full turn of the adjustment screw cm ³ /rev (cu.in./rev)	Minimum adjustable flow cm ³ /rev (cu.in./rev)
AR16	1.5 (.092)	6 (.366)
AR22	2.1 (.128)	8.5 (.519)



Graphic Symbol

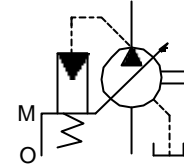

Specifications

Model Numbers	Geometric Displacement cm ³ /rev (cu.in./rev)	Operating Pres. MPa (PSI)		Shaft Speed Range r/min.		Approx. Mass kg (lbs.)
		Rated	Intermittent ★1	Max.	Min.	
AR16-FR01*-20/2080/ 2090	15.8 (.964) 22.2 (1.355)	16 (2320)		1800 1800	600 600	9.8 (21.6)

★1. When setting the pressure, make sure the full cut-off pressure never exceeds the maximum intermittent pressure.

Model Number Designation

AR16	-F	R	01	B	-20	*
Series Number	Mounting	Direction of Rotation	Control Type	Pres. Adj. Range MPa (PSI)	Design Number	Design Std.
AR16 (15.8 cm ³ /rev)	F: Flange Mtg.	(Viewed from Shaft End) R: ★1 Clockwise (Normal)	01: Pressure Compensator Type	B: 1.2 - 7 {170 - 1020}	20	Refer to ★2
AR22 (22.2 cm ³ /rev)				C: 2.0 - 16 {290 - 2330}		

★1. Available to supply pump with anti-clockwise rotation. Consult Yuken for details.

★2. Design Standards:

None.....Japanese Standard "JIS"

80.....European Design Standard

90.....N. American Design Standard

Pipe Flange Kits

Pipe flange kits are available.

When ordering, specify the kit number from the table below.

Pump Model Numbers	Name of Port	Pipe Flange Kit Numbers				
		Threaded Connection			Socket Welding	
		Japanese Standard "JIS"	European Design Standard	N. American Design Standard	Japanese Standard "JIS" European Design	N. American Design Standard
AR16-FR01	Suction	F5-06-A-1021	F5-06-A-10801	F5-06-A-10901	F5-06-B-1021	F5-06-B-10901
AR22-FR01	Discharge ★	_____	_____	_____	_____	_____

★ Discharge port is available only for the threaded connections.

■ Pipe Flange Kit for Suction Port

F5-06-A-1021/10901 F5-06-B-1021/10901

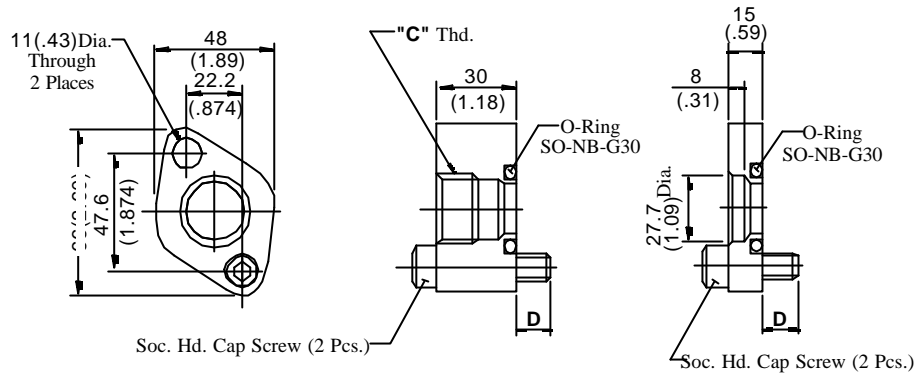

Kit Numbers	"C" Thd.	D mm (IN.)	Soc. Hd. Cap Screw	Approx. Mass kg (lbs.)
F5-06-A-1021	Rc3/4	15 (.59)	M10 × 45 Lg.	0.5 (1.1)
F5-06-A-10901	3/4 NPT	14.45 (.57)	3/8-16UNC × 1-3/4 Lg.	
F5-06-B-1021	—	16.75 (.66)	3/8-16UNC × 1-1/4 Lg.	0.3 (.66)

F5-06-A-10801

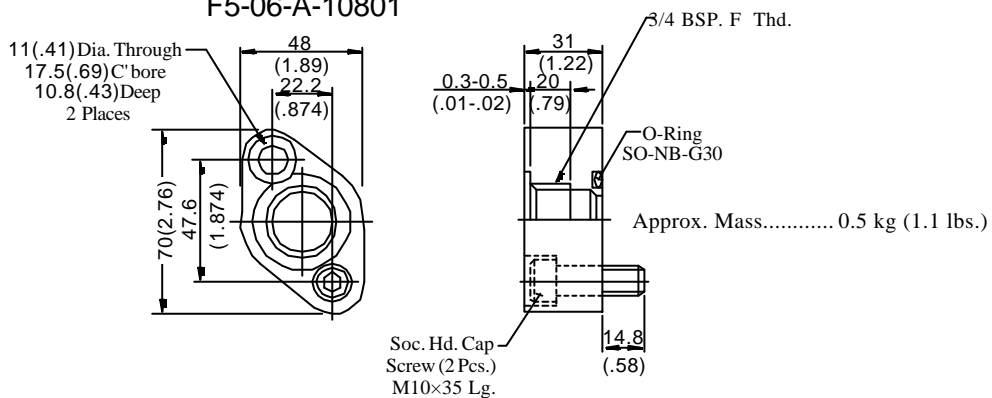

**DIMENSIONS IN
MILLIMETRES (INCHES)**

■ Mounting Bracket Kits

Mounting bracket available on separate order.

Pump Model Numbers	Mtg. Bracket Kit Numbers	Approx. Mass kg (lbs.)
AR16/AR22-FR01	LP-1A-10	2.2 (4.9)

The mounting bracket kit consists of a mounting bracket, 2 hex. bolts and 2 plain washers.

Mtg. Bracket Kit: LP-1A-10

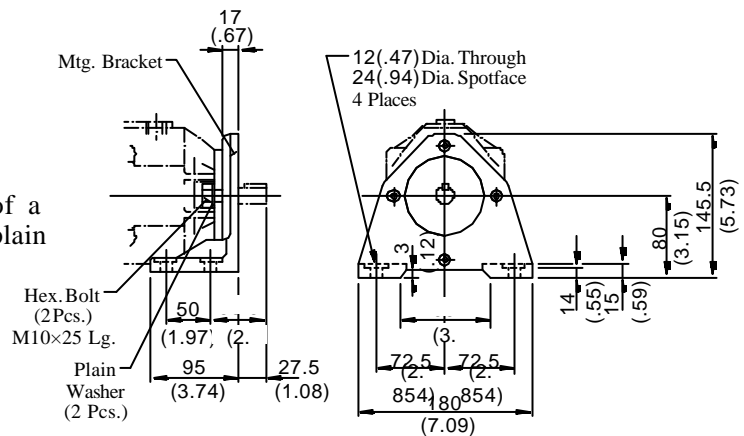

Type "AR 16" Viscosity 20 mm²/s (100 SSU) [ISO VG32 Oils, 50°C (122°F)]

Performance Characteristic Curve

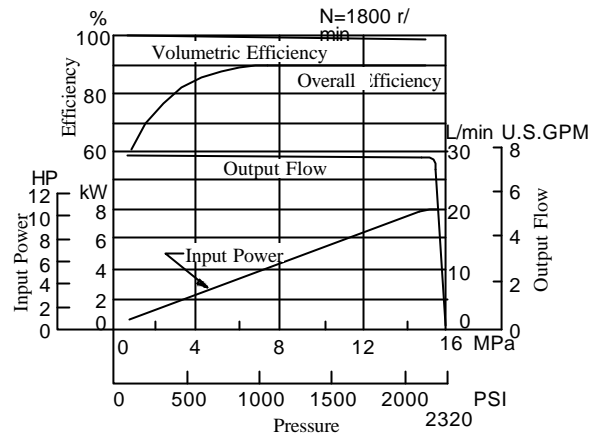
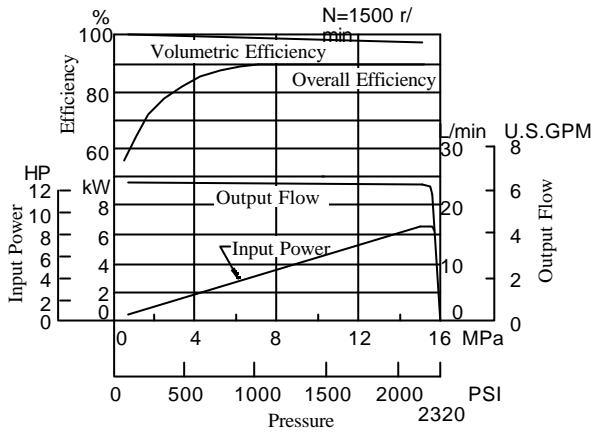

Input Power

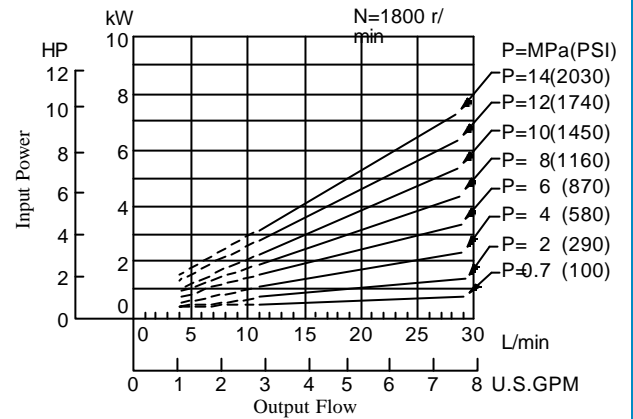
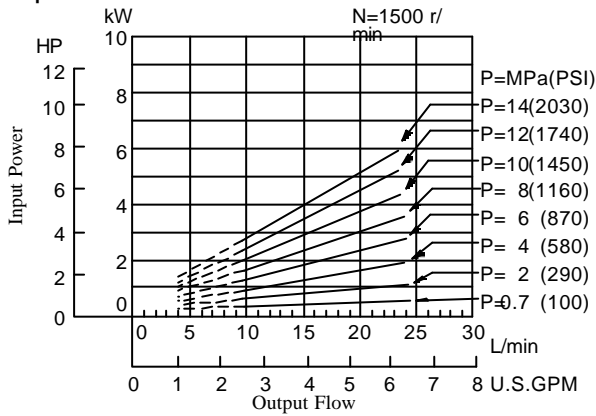

Full Cut-off Power

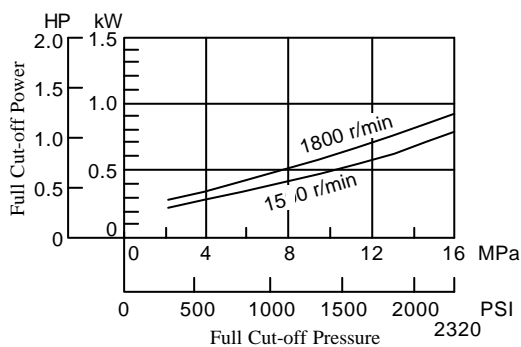

Drain

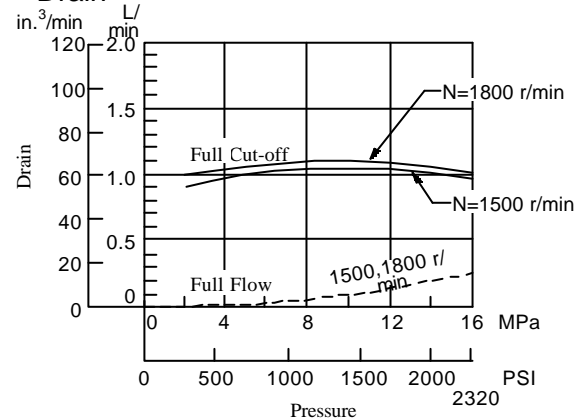

Noise Level [One metre (3.3 ft.) horizontally away from pump head cover]

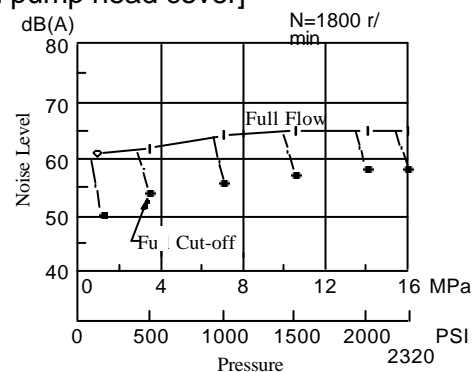
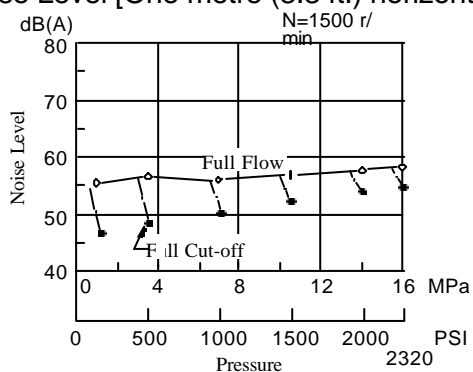

Typical Pump Characteristics

Type "AR 22" Viscosity 20 mm²/s (100 SSU) [ISO VG32 Oils, 50°C (122°F)]

Performance Characteristic Curve

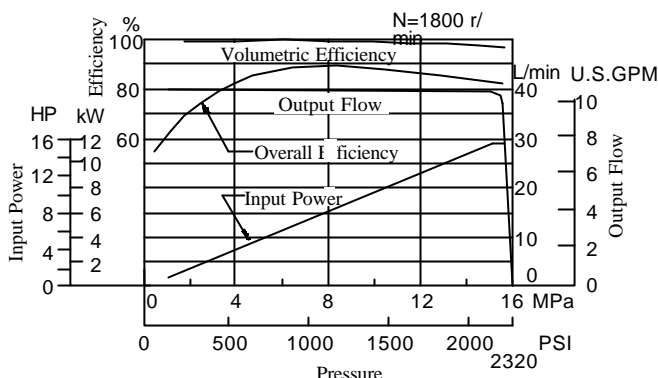
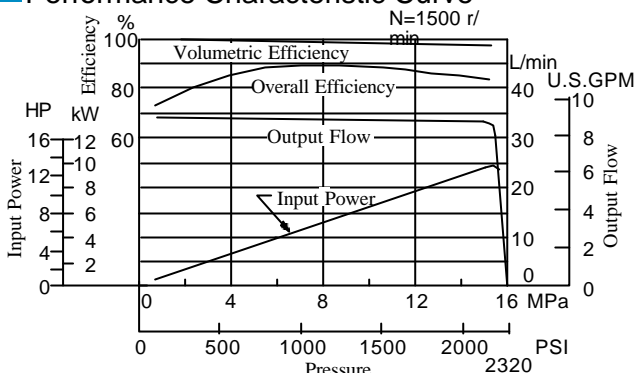

Input Power

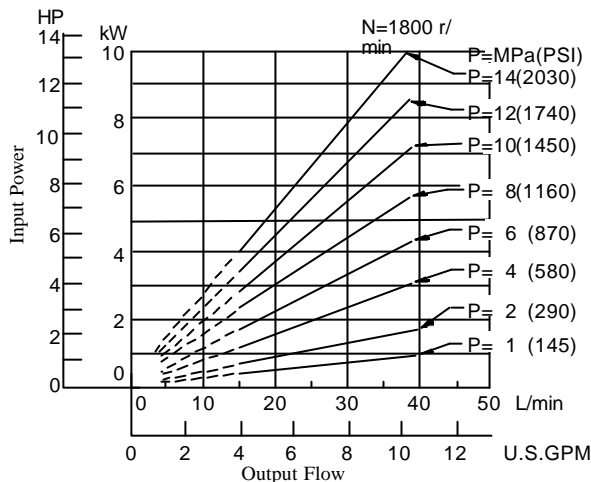
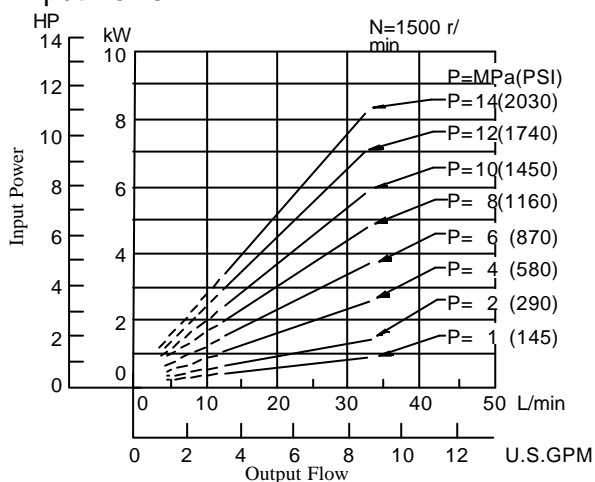

Full Cut-off Power

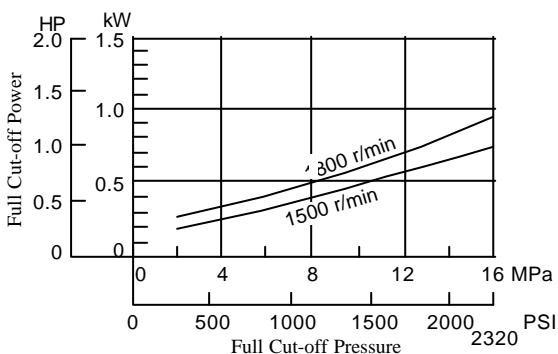

Drain

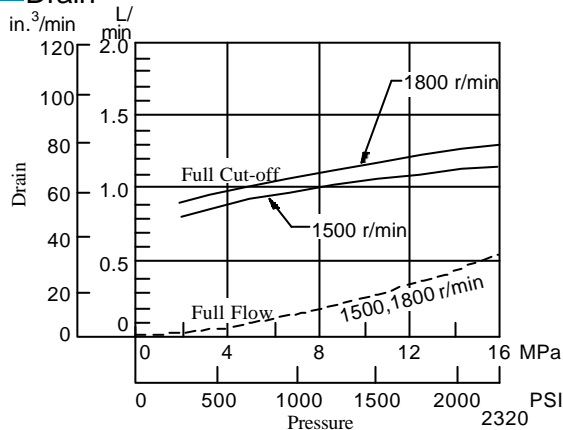

Noise Level [One metre (3.3 ft.) horizontally away from pump head cover]

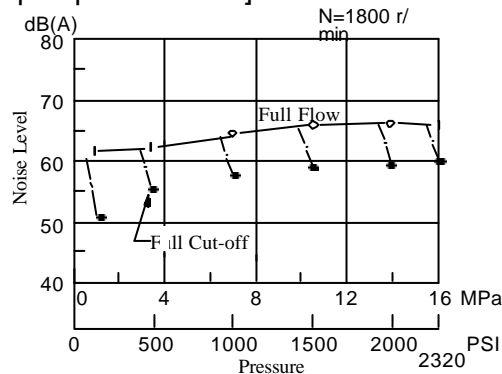
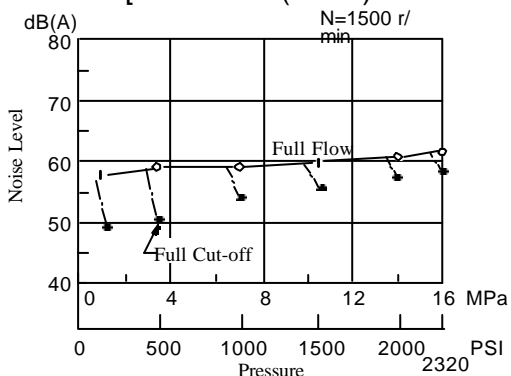

Response Characteristics Change in Accordance with Circuits and Operating Conditions.

Test Circuit and Conditions

Result of Measurement

Circuit

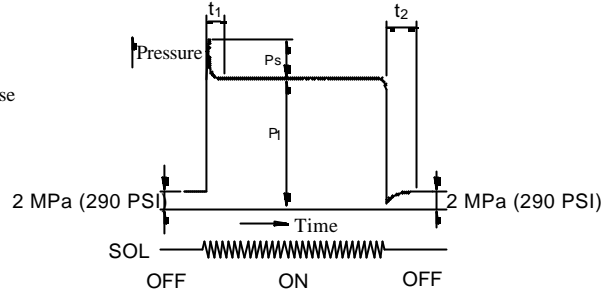
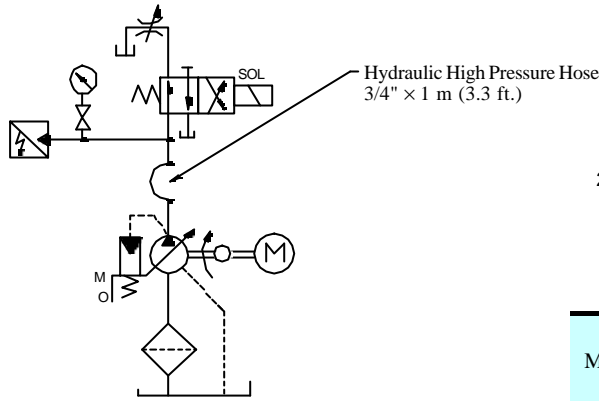

Model	Full Cut-off Pressure P ₁ MPa (PSI)	Response Time ms		Overshoot Pressure MPa (PSI)
		t ₁	t ₂	
AR16	16 (2320)	60	65	5.6 (810)
AR22		70	70	

Conditions

Drive Speed : 1500 r/min
Hydraulic Fluid : ISO VG32 oil
Oil Temperature : 50 °C (122 °F)
Viscosity : 20 mm²/s (100 SSU)

AR16-FR01*-20/2080/2090
AR22-FR01*-20/2080/2090

DIMENSIONS IN
MILLIMETRES (INCHES)

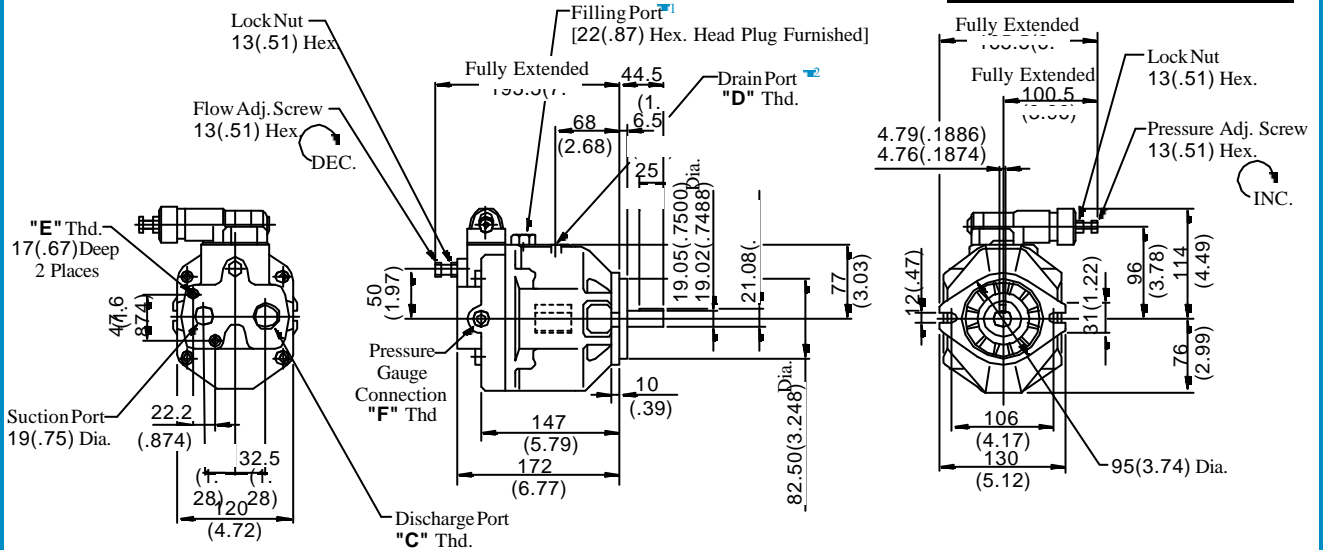

- ★1. Install the pump so that the "Filling port" is at the top.
- ★2. A screw-in torque of fitting is 40 - 50 Nm (354-443 IN. lbs.). Do not apply bending and thrust torque to the fitting.

Model Numbers	"C" Thd.	"D" Thd.	"E" Thd.	"F" Thd.
AR16/AR22-FR01*-20	Rc 3/4	Rc 3/8	M10	Rc 1/4
AR16/AR22-FR01*-	3/4BSP.F	3/8BSP.F		1/4BSP.Tr
2080	3/4 NPT	3/8 NPT	3/8-16 UNC	1/4 NPT

Spare Parts List

AR16-FR01*-20/2080/2090
AR22-FR01*-20/2080/2090

CAUTION

When making replacement of seals or bearing, please do it carefully after reading through the relevant instructions in the Operator's Manual.

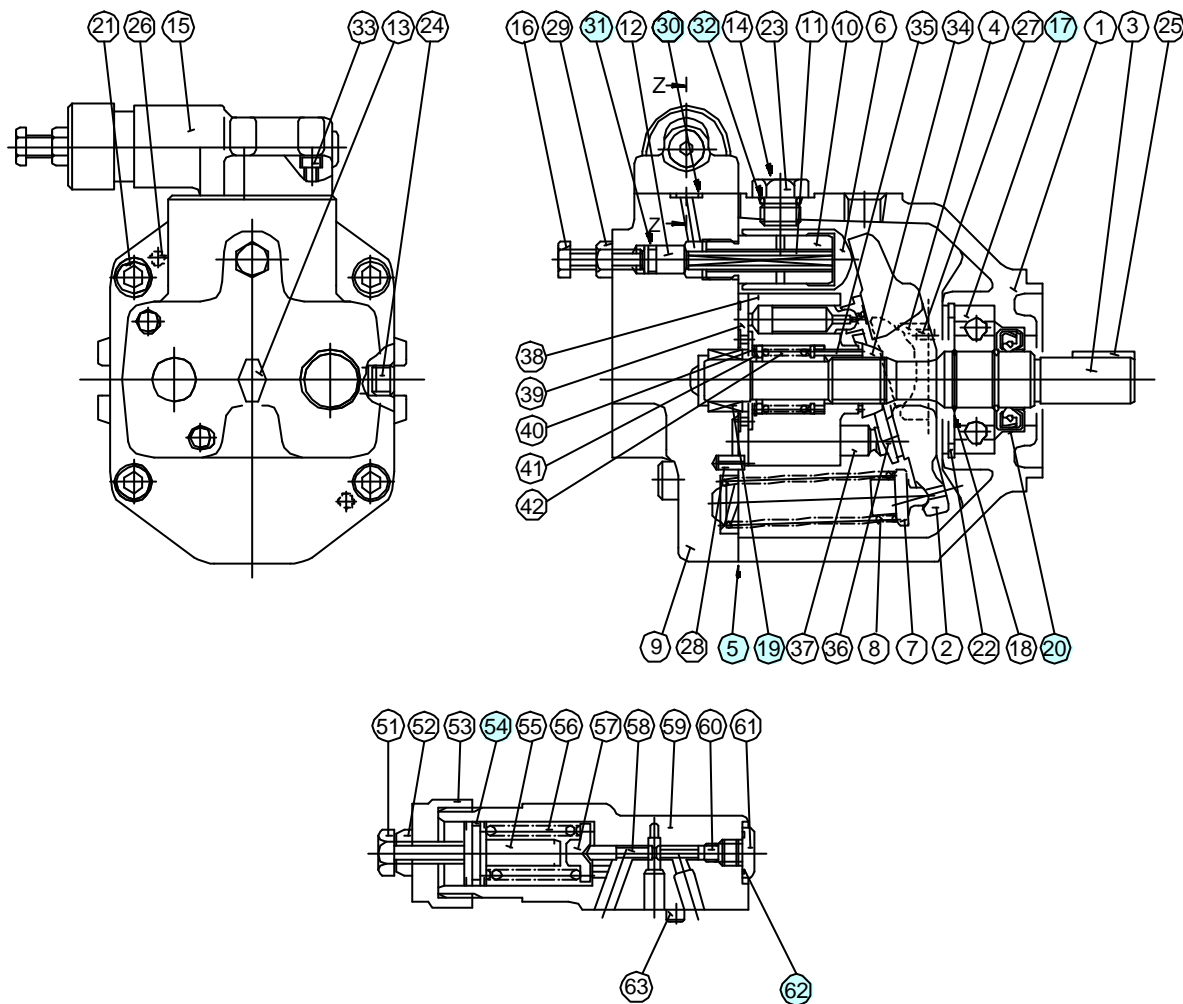

Section Z-Z

Item	Name of Parts	Part Numbers		Qty.
		AR16-FR01	AR22-FR01	
5*	Gasket	1302-PK312891-5		1
17	Bearing	6305		1
19	Bearing	HMK 1715 V2	Z30-1303-PK410300-8	1
20*	Oil Seal	TCN 254511		1
30*	O-Ring	SO-NB-P9		3
31*	O-Ring	SO-NA-P8		1
32*	O-Ring	SO-NB-P14		1
54*	O-Ring	SO-NA-A018		1
62*	O-Ring	SO-NB-P10		1

*When ordering seals, please specify the seal kit number from the table below.

Pump Model Numbers	Seal Kit Number
AR16-FR01*-20/2080/2090	KS-AR16-01-20
AR22-FR01*-20/2080/2090	

Specifications

Description		Model	A16-*-R-01-*-K-32*	AR16-FR01*-20*	A22-*-R-01-*-K-32*	AR22-FR01*-20*
Geometric Displacement			15.8 cm ³ /rev (.964 cu.in./rev)		22.2 cm ³ /rev (1.355 cu.in./rev)	
Operating Pres.	Rated		16 MPa (2320 PSI)			16 MPa (2320 PSI)
	Intermittent		21 MPa (3050 PSI)	16 MPa (2320 PSI)	16 MPa (2320 PSI)	
Shaft Speed Range			600 -1800 r/min			600 -1800 r/min
Approx. Mass (Flange Mtg.)			16.5 kg (36.4 lbs.)	9.8 kg (21.6 lbs.)	16.5 kg (36.4 lbs.)	9.8 kg (21.6 lbs.)

Interchangeability in Installation

Model Numbers		Interchangeability in Installation			
"A" Series	"AR" Series	Mtg. Flange & Shaft End	Piping		
			Suction Port	Discharge Port	Drain Port
A16-*-R-01-*-K-32*	AR16-FR01*-20*	Yes	Yes	No	No
A22-*-R-01-*-K-32*	AR22-FR01*-20*				

Comparison of dimensions between "A" series and "AR" series are shown below.

A16/A22-F-R-01-*-K

Note: Dimensions with star mark* are identical to each other.

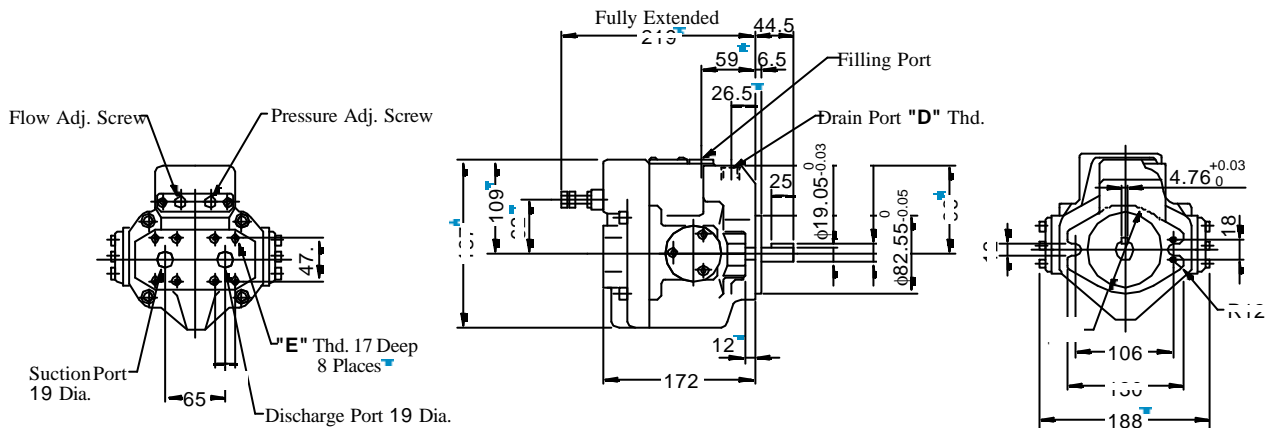

Model Numbers	"C" Thd.	"D" Thd.	"E" Thd.	"F" Thd.
A16/A22-F-R-01-*-K-32	—	Rc 3/8	M10	—
A16/A22-F-R-01-*-K-3280	—	3/8BSP.F		—
AR16/22-FR01*-20	Rc 3/4	Rc 3/8	M10	Rc 1/4
AR16/22-FR01*-2080	3/4BSP.F	3/8BSP.F		1/4BSP.Tr
AR16/22-FR01*-2090	3/4 NPT	3/8 NPT	3/8-16 UNC	1/4 NPT

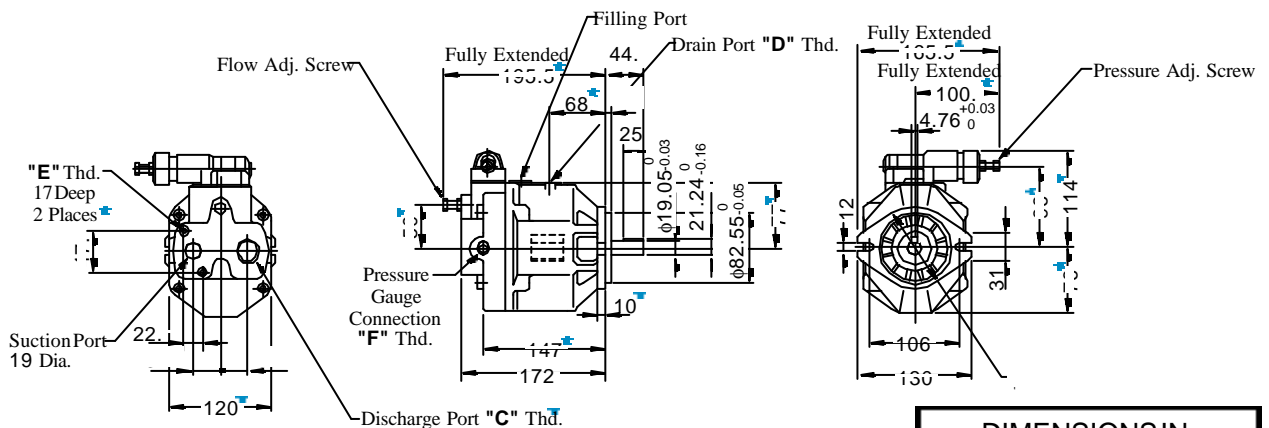

**DIMENSIONS IN
MILLIMETRES**